

Chemical Reviews

Volume 85, Number 2

April 1985

Photochemical Reactions Involving Matrix-Isolated Atoms

ROBIN N. PERUTZ

Department of Chemistry, University of York, Heslington, York, YO1 5DD, U.K.

Received June 27, 1984

Contents

I. Introduction to Matrix Isolation	77
II. Photochemistry of Atoms Deposited in Matrices	78
A. Photoelectron Transfer	78
B. Photoinduced Coordination of Ligands and Insertion	79
C. Photoinduced Aggregation	81
III. Photochemical Generation of Atoms in Matrices: Sources	82
IV. Photochemical Generation of Atoms in Matrices: Detection	84
A. ESR	84
B. UV/Visible Absorption	84
C. UV/Visible Emission	84
D. Reaction To Generate Molecular Species	85
V. Synthesis in Matrices Using Photochemical Atom Sources	87
A. Matrix Ratios and General Principles	87
B. Examples of Photochemical Atom Transfer and Abstraction	88
C. Mechanisms of Photochemical Atom Transfer	90

I. Introduction to Matrix Isolation

The ability of an inert solid to stabilize a radical by isolating it from other reactive molecules is exemplified by the mineral lapis lazuli. This material owes its blue color to the S_3^- radical ion which is *isolated* in an aluminosilicate *matrix*.¹ The principle of using rare gas solids and solid nitrogen as host matrices for the isolation of radicals was pioneered by Pimentel and associates in the fifties.² These materials offer the advantages of transparency over a range from the far infrared to the far vacuum ultraviolet, of extreme inertness, and of rigidity at suitably low temperatures (4–20 K). Thus, molecules which might have lifetimes as low as 10^{-8} s under fluid conditions, are stable in matrices in their *ground* electronic and vibrational states. They may then be studied by a variety of spectroscopic methods: IR, UV/vis, vacuum UV (VUV), and X-ray absorption, ESR, Raman, Mössbauer, UV/vis emission, and ultraviolet photoelectron spectroscopy, and magnetic circular



Robin Perutz was born in 1949 in Cambridge, England. He received a B.A. from Cambridge University in 1971, and after research with Professor J. J. Turner in Cambridge and Newcastle upon Tyne, his Ph.D. in 1975. His doctoral work was concerned with the structure and reactivity of metal carbonyl fragments in low-temperature matrices, particularly the group 6 pentacarbonyls. After a post-doctoral year at the Max-Planck Institut für Strahlenchemie in Mülheim, F.R.G., he held Demonstratorships at the Universities of Edinburgh (1975–1977) and Oxford (1977–1983). He is now a Lecturer in Chemistry at the University of York where he is studying intermediates in organo-transition-metal photochemistry by matrix isolation and flash photolysis.

dichroism have all been employed.³ Other methods such as secondary-ion mass spectrometry and NMR are currently undergoing trials on stable molecules.⁴

Photolysis, either in situ or during deposition, is one of the most important methods of generating unstable molecules in matrices. The principle may be exemplified by the cocondensation of NO and NO₂ in solid nitrogen to form N₂O₃. Here solid nitrogen acts as an inert matrix which suppresses the rotation of the smallest molecules. (In argon molecules such as H₂O rotate). The unstable oxygen-centered isomer is generated by photolysis and characterized by IR spectroscopy.⁵

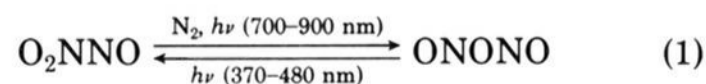

An extension of the photochemical method is the atom-transfer method. Here, the photolysis of one

reagent (e.g., ozone) generates an atom which reacts with a second reagent both embedded in a matrix (see section VB) e.g.:⁶

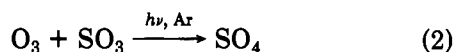

The matrix method may also be extended to more reactive matrices: N_2 , CO , O_2 , CO_2 , CH_4 , SF_6 allowing a much greater range of unstable molecules to be studied, e.g.:^{7,8}

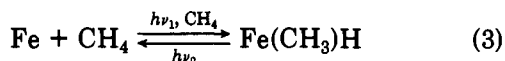

In some circumstances a rare-gas matrix will also prove reactive:⁹⁻¹¹

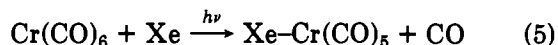
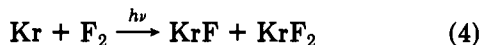

The ability of rare gases to undergo reaction leads to the question of perturbation by the matrix. For the vast majority of molecules, both stable and unstable, spectral perturbations are less than 1% of absorption energies.^{12,13,36} There are *no convincing cases in which molecular symmetry differs in gas and matrix phases*. There are no authentic examples of a change in molecular ground state in the matrix, and only one example of a change in atomic ground state—the nickel atom.¹⁴ Indeed there is considerable evidence that the matrix has almost no influence on molecular rearrangement in the adiabatic limit of slow relaxation. However, in appropriate circumstances such as those illustrated in (4) and (5) reaction with krypton or xenon does occur. Even if perturbation of the ground state is insignificant, interaction between the matrix and an electronically excited state can have a profound effect on the photochemistry as proves to be the case in eq 3 (see section IIB, IIC, or the photolysis of CO_2 in Ar (section III)). As the photon energies increase into the vacuum UV, the band gap of the matrix material is approached. At such energies there may be substantial perturbation of spectra and the matrix is likely to participate in photoprocesses (see accompanying review, section VC).²⁵ The matrix may also influence the outcome of photochemistry via the cage effect discussed in section VC4. Thus molecules such as ICl fail to undergo permanent dissociation in a matrix.

For an overview of the matrix isolation method and for discussion of matrix properties, deposition methods, methods of generating unstable molecules, matrix perturbations etc., the reader is referred to alternative reviews.^{3,16-24} This pair of reviews is confined to matrix photochemistry. In the first I will discuss photolysis of atoms, photochemical generation and detection of atoms, and photochemical atom-transfer reactions. In the second,²⁵ I will review the photochemistry of small molecules in matrices. Literature coverage should be complete through 1983 with selective coverage up to mid-1984.

II. Photochemistry of Atoms Deposited in Matrices

This review is devoted to the photochemistry of atoms in matrices; nevertheless only a small part of it

concerns reactions following absorption of light by the atoms themselves. Three reaction types have been discovered which fall into this category: (i) photoinduced electron transfer, (ii) photoinduced insertion and ligand coordination, (iii) photoinduced aggregation. The reactions of atoms in electronically excited states generated by irradiation of molecular precursors will be discussed in later sections.

A. Photoelectron Transfer

When alkali atoms are cocondensed with strong electron acceptors in matrices, electron transfer takes place spontaneously. For instance, when sodium vapor and fluorine are condensed with argon, $\text{Na}^+\cdots\text{F}_2^-$ is formed.²⁶ Kasai discovered that electron transfer to weaker electron acceptors could be stimulated by irradiation well below the metal's ionization energy. He could follow the decay of the Na and generation of the H atoms in reaction 6 by ESR:²⁷

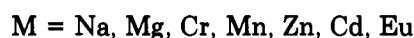
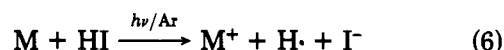

Irradiation in the Na D line (589 nm; cf. ionization energy $41\,100\text{ cm}^{-1} = 243\text{ nm}$) was sufficient to transfer the electron to hydrogen iodide and several molecular substrates.²⁸ Two possible outcomes are illustrated: dissociative electron capture (eq 6), and simple electron transfer:

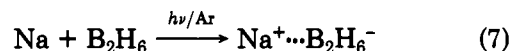

The striking ESR spectrum of $^{11}\text{B}_2\text{D}_6^-$ shows that the two B atoms are equivalent. Very recently, B_2H_6^- has been observed by ESR in solution and assigned a D_{3d} unbridged structure.²⁹ These reactions are possible even when the photon energy is less than the difference between donor ionization energy (IE) and acceptor electron affinity (EA) because of the electrostatic attraction of the ions. At 7–8 Å separation (R) an electron affinity of 1eV is sufficient for the use of yellow light (eq 8).

$$h\nu > \text{IE}(\text{donor}) - \text{EA}(\text{acceptor}) - \frac{e^2}{4\pi\epsilon_0\epsilon R} \dots \quad (8)$$

At about the same time as Kasai's experiments, Milligan and Jacox employed a similar method for the production of C_2^- ³⁰ and HX_2^- ($\text{X} = \text{Cl}, \text{Br}$)^{31,32} using IR and UV/vis detection. In experiments with vacuum ultraviolet (VUV) photolysis of acetylene and Cs the yield of C_2^- was enhanced relative to experiments without Cs. In experiments with Cs and HX dimers, the VUV source was replaced by an unfiltered mercury arc. Since short wavelength light was required, these authors did not follow up Kasai's investigations of the energetics of electron transfer. However, their results had considerable importance because they demonstrated that ions could be produced in matrices by vacuum UV photolysis in the absence of alkali atoms. Recently, both condensation with alkali atoms and co-condensation of salts with molecules (e.g., $\text{CsCl} + \text{HCl} \xrightarrow{\text{Ar}} \text{Cs}^+\text{HCl}_2^-$)³³ have been used to test for ion production. Further details of experiments involving matrix-isolated ions will be found in the succeeding review²⁵ and elsewhere.^{22,23}

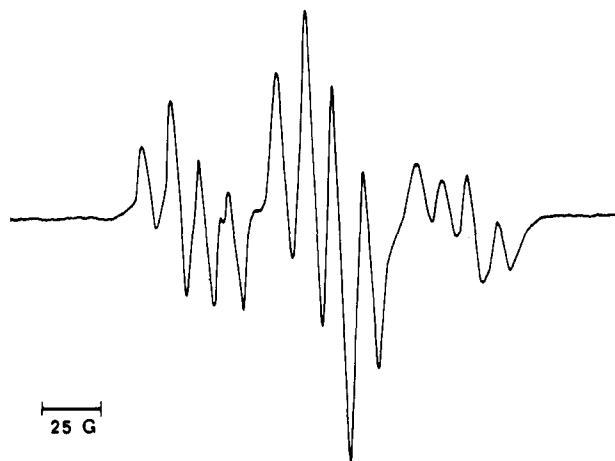
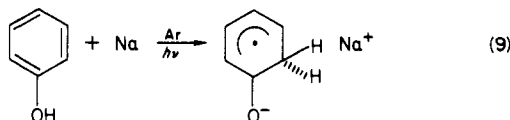
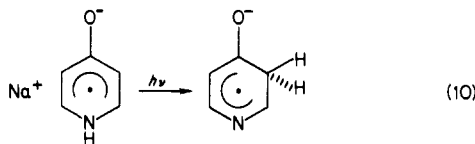

Figure 1. ESR spectrum of Na/C₂H₂(1%)/Ar matrix after irradiation first with $\lambda > 580$ nm and then with $\lambda > 500$ nm showing signal due to Na⁺[C=CH₂]⁻, $g = 2.005$, $A^H = 57.5$ G, $A^{Na} = 12.3$ G (²³Na: $I = 3/2$). Reproduced with permission from ref 34. Copyright 1982, American Chemical Society.

Further experiments illustrate the potential (under-used, I believe) of the photoelectron-transfer method. Photolysis ($\lambda > 580$ nm) of a sodium-doped matrix containing phenol results in production of the molecular anion radical in the keto form:³⁴



Similarly the radical anions of catechol, resorcinol, hydroquinone, and 2-hydroxypyridine are shown by ESR to have the keto structure. Interestingly, no hydrogen transfer was observed with 3-hydroxypyridine, while hydrogen transfer could be effected photochemically with the 4-hydroxypyridine anion:³⁴



Pyrrole was also found to undergo hydrogen transfer on electron capture. Similarly, photolysis ($\lambda > 500$ nm) of acetylene (Figure 1) in Na-doped argon yields the vinylidene anion radical,³⁴ reminiscent of the alkyne-vinylidene rearrangements observed on coordination to transition-metal complexes:³⁶

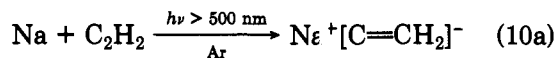

At higher acetylene concentrations a spectrum due to perturbed vinyl radicals is observed.

UV photolysis of Ar/N₂O/M (M = Na, Cs) deposits proved to be a neat way of generating O⁻, since N₂O⁻ dissociated under these conditions.³⁵ Reaction of O⁻ with excess N₂O led to [O₂N⁻N], but if the matrix was additionally doped with O₂, the ozonide ion O₃⁻ and the O₄⁻ were generated. These species were identified by their IR spectra using isotopic substitution.³⁵

The product of photolyzing M/SF₆/Ar (M = Na, K) matrices has been assigned as SF₆⁻.³⁷ However, the alternative product SF₅⁻ has not been excluded (see section VA5 of ref 25). Dissociative electron capture

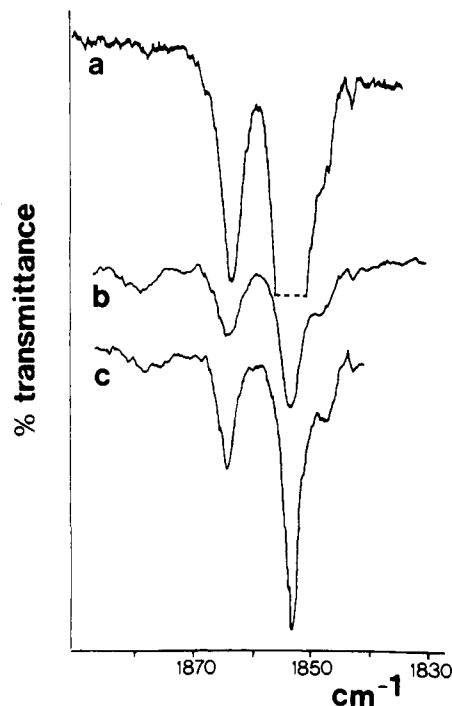
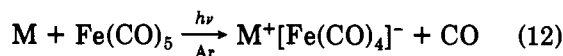
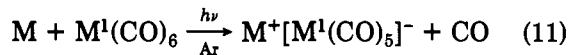

Figure 2. IR spectrum of Fe(CO)₄⁻ in an argon matrix produced by (a) cocondensation with sodium atoms and visible photolysis, (b) electron bombardment, and (c) vacuum UV irradiation. Reproduced with permission from ref 38. Copyright 1981, American Chemical Society.

is observed on visible photolysis of matrices containing alkali metals and binary metal carbonyls (see Figure 2).³⁸



The anionic products were also generated by VUV photolysis in the absence of alkali metal and by low energy electron bombardment during deposition. IR spectra of partially ¹³CO substituted materials were used to demonstrate a C_{4v} structure for [Cr(CO)₅]⁻ and a C_{3v} structure for [Fe(CO)₄]⁻.

B. Photoinduced Coordination of Ligands and Insertion

(1) **Coordination of CO, N₂, and C₂H₄.** The coordination of ligands such as CO, N₂, O₂, and C₂H₄ usually occurs spontaneously on cocondensation of metal vapor with the ligands into matrices.³⁹ However, there are several instances in which unreacted metal atoms may be detected in reactive matrices (e.g., Fe in N₂).⁴⁰ It has recently been discovered that coordination is sometimes stimulated photochemically. Thus residual unreacted Fe atoms in CO have been shown by Mössbauer spectroscopy to react to form Fe(CO)₅ on UV/vis photolysis;⁴¹ similarly residual iron atoms react to form Fe(C₂H₄) in a C₂H₄ matrix.⁴² Another recent example is the formation of molybdenum dinitrogen complexes from Mo in N₂. In this case ⁷S → ⁷P stimulation of Mo at 350 nm results in substantial increases in Mo(N₂)_x

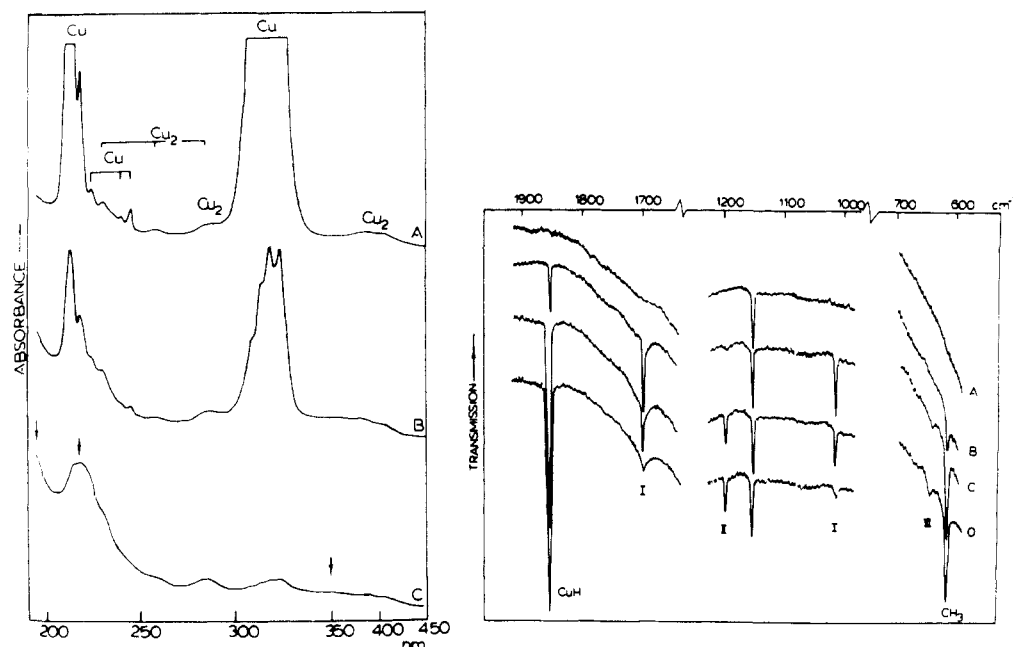
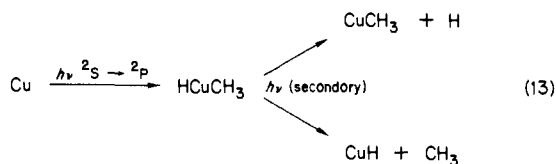

Figure 3. Left: UV absorption spectra of Cu atoms in solid methane at 12 K ($\text{Cu}/\text{CH}_4 \approx 1/10^4$) showing (A) freshly deposited matrix, (B) 1-min 320-nm irradiation, (C) 15-min 320-nm irradiation causing decay of Cu atom bands. Arrows depict product bands. Right: IR spectra of similar Cu/ CH_4 matrices showing (A) freshly deposited matrix, (B) 10-min, (C) 50-min, (D) 70-min 320-nm irradiation. Reproduced with permission from ref 46. Copyright 1981, American Chemical Society.

products at the expense of atomic Mo.⁴³ In contrast to the Fe/ C_2H_4 reaction annealing of the matrix did not prove to be an alternative method of inducing reaction. The products were assigned as MoN_2 , $\text{Mo}_x(\text{N}_2)_x$, and D_{3h} $\text{Mo}(\text{N}_2)_3$ according to the concentrations of Mo and N_2 . However, I view the latter assignment with some scepticism because of the established C_{3v} structure of $\text{Mo}(\text{CO})_3$,⁴⁴ and the theoretical work on $d^6 \text{ML}_3$.⁴⁵

(2) **Insertion into CH_4 , H_2 , and O_2 .** The most striking reactions of matrix-isolated metal atoms are those with methane and dihydrogen. Initial studies by Billups et al. showed that Mn, Fe, Co, Cu, Zn, Ag, and Au inserted into methane to form species containing M-H and M- CH_3 bonds, but that Ca, Ti, Cr, and Ni were unreactive.⁸ Simultaneous studies of the Cu/ CH_4 system by Ozin et al. using selective irradiation and a combination of UV, IR, and ESR spectroscopy (Figure 3) showed that the reaction proceeded as below:⁴⁶



These assignments were confirmed by ^2H and ^{13}C substitution. There is evidence that $\text{Cu}({}^2\text{D})$ generated by photolysis of Cu_2 reacts with CH_4 to form CuCH_3 .⁴⁷ The Fe/ CH_4 system, also probed by selective irradiation, is found to differ significantly from the Cu/ CH_4 reactions. The primary product is again the metal (methyl) hydride, but this complex reductively eliminates CH_4 on photolysis without forming any radical products,⁷ perhaps because of a nonlinear H-Fe-C skeleton (see eq 3). Manganese atoms react similarly to iron, but there are differences in the kinetics of reaction of CH_3MnH .⁴⁸ Use of ethane in place of methane, either with Cu or Fe results in C-H bond insertion and not C-C insertion. However, C-C cleavage is thought to occur with cyclopropane.⁴⁹

The reaction of Cu with H_2 to form $\text{CuH} + \text{H}$ has been observed following ${}^2S \rightarrow {}^2P$ excitation of Cu in Kr/ H_2 matrices. Intriguingly, the reaction with HD, monitored by ESR, shows a preference for the pathway:⁵⁰

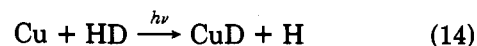

Again atomic iron and manganese differ from Cu in following a concerted pathway:⁴⁸

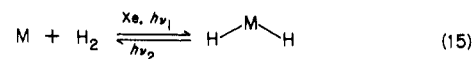

All three IR fundamentals of FeH_2 have been observed and the bond angle is estimated as $\sim 120^\circ$. The kinetic isotope effect for the formation of FeH_2 is relatively low (5-6) considering the temperature, and no kinetic isotope effect is observed for the reverse reaction. Thus both oxidative addition and reductive elimination are thought to be concerted.

The reactions of matrix-isolated atoms with H_2 and CH_4 are comparable to those of transition-metal complexes. For instance, $\text{W}(\eta^5\text{-C}_5\text{H}_5)_2\text{H}_2$ and $\text{W}(\eta^5\text{-C}_5\text{H}_5)_2(\text{CH}_3)(\text{H})$ reductively eliminate H_2 and CH_4 , respectively, on photolysis.⁵¹ In this situation, it is thought that a cis disposition of the ligands is necessary for concerted elimination. Oxidative addition of C-H bonds has also been observed as in the photochemical reaction of $\text{W}(\eta^5\text{-C}_5\text{H}_5)_2\text{H}_2$ with C_6H_6 ⁵² and of $\text{Ir}(\eta^5\text{-C}_5\text{H}_5)(\text{CO})_2$ with CH_4 .⁵³ However, the reacting species are likely to differ considerably. Thus the atomic metals require $4s \rightarrow 4p$ excitation. It is argued that the diffuse $4p$ electron assists in forming an exciplex with CH_4 or H_2 . In contrast, the tungsten system probably reacts via the 3E_2 ground state of $\text{W}(\eta^5\text{-C}_5\text{H}_5)_2$. Perhaps it is more appropriate to compare the behavior of Fe atoms to the insertion reactions of $\text{S}({}^1\text{D})$.⁵⁴

The reactions of Cu with O_2 in matrices have been studied on numerous occasions, but the reaction patterns are only now becoming clear. Ground state (${}^2\text{S}$)Cu

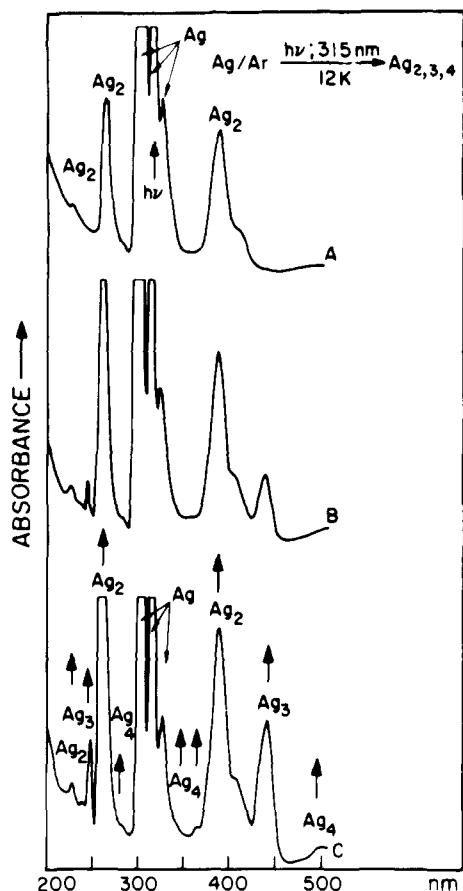

Figure 4. UV/visible spectra of Ag/Ar ($\sim 1/10^3$) deposits: (A) at 10 K; (B) after 15-min 315-nm photolysis; (C) after 45-min further photolysis at 315 nm, showing decay of atomic Ag and concomitant growth of Ag_2 and Ag_3 . Reproduced with permission from ref 64. Copyright 1978, American Chemical Society.

reacts with O_2 to form $\text{Cu}(\eta^1\text{-O}_2)$ in matrices doped with O_2 ; this species reacts on 483-nm laser photolysis to generate OCuO , characterized by vibrational progressions in absorption and fluorescence. Alternatively OCuO may be generated by $^2\text{S} \rightarrow ^2\text{P}$ excitation of Cu atoms in Xe/O_2 matrices, perhaps via a $\text{Cu}(^2\text{D})$ intermediate.^{55,56} Earlier studies^{57,58} (see ref 55) were misinterpreted because of a failure to recognize the photosensitivity of Cu or its dioxygen complexes⁵⁵ (see also sections VB2 and VC3) and because of inadequate isotopic data.⁵⁶ We may also surmise that the photolysis of $\text{Mn}/\text{CS}_2/\text{Ar}$ matrices to generate MnS ⁵⁹ may have involved photoprocesses of both Mn and CS_2 ; similarly, absorption by the Mn may have contributed to production of MnF and MnF_2 on photolysis of $\text{Mn}/\text{F}_2/\text{Ar}$ matrices.⁶⁰

(3) **Insertion into H_2O .** Cocondensation of Ga or In vapor with $\text{Ar}/\text{H}_2\text{O}$ mixtures has been shown to result in a $\text{M}\cdots\text{OH}_2$ complex, which photolyzes to generate HMOH .⁶¹ Electronic spectra suggest that this photosensitive complex may be described as a slightly perturbed metal atom.⁶¹ It is notable that the unperturbed metal atoms were not affected by photolysis. The observation of a photosensitive $\text{Si}\cdots\text{OD}_2$ complex, although superficially analogous, must surely involve much more drastic perturbation.⁶²

C. Photoinduced Aggregation

When matrices containing isolated metal atoms, M, are irradiated in their atomic transitions, both emission

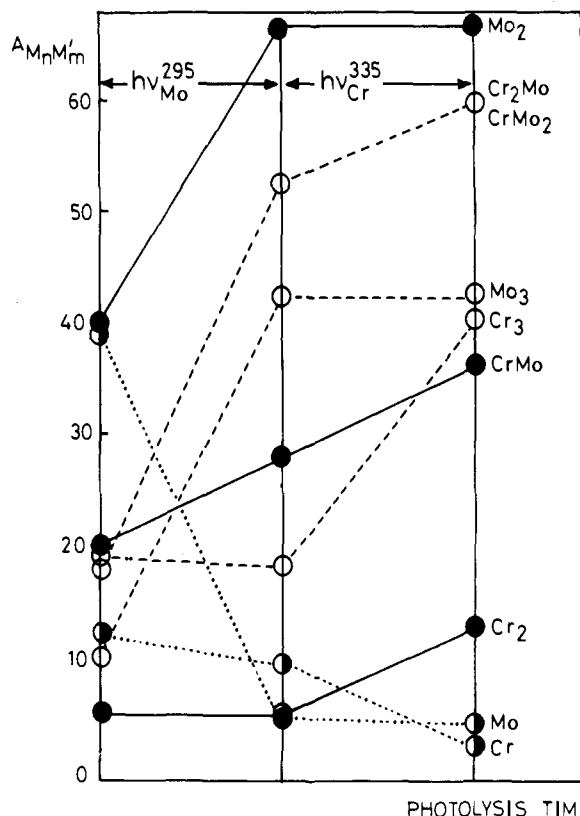

Figure 5. A schematic representation of selective photoaggregation experiments employing $\text{Cr}/\text{Mo}/\text{Kr} = 1/1/10^3$ mixtures deposited at 12 K and photolyzed at 295 nm (Mo atom absorption) followed by 335 nm (Cr atom absorption). The Cr and Mo atom absorbances are recorded at $1/10$ the scale of the cluster absorbances. Reproduced with permission from ref 65. Copyright 1978, American Chemical Society.

and increased absorption by metal dimers and trimers, M_2 , M_3 , may be observed. Increased absorption of M_2 is indicative of photoinduced formation of dimers—photoaggregation. Emission from excited states of M_2 may result either from energy transfer to M_2 molecules already present in the matrix, or from photoaggregation processes causing direct production of excited M_2 . Thus the early observation of Cd_2 emission on excitation of Cd atomic transitions in a matrix⁶³ could be explained by either mechanism. Direct evidence for photoaggregation was first reported by Ozin and Huber⁶⁴ on irradiation of matrix-isolated Ag atoms at 315 nm ($^2\text{P} \leftarrow ^2\text{S}$) UV/vis absorption bands assigned to Ag_2 and Ag_3 grew (Figure 4). Above 10 K higher clusters could be obtained. Similar effects were observed for Cr, Mo,⁶⁵ Cu,⁶⁶ Rh,⁶⁷ and Na⁶⁸ and by using two metals, mixed clusters such as CrMo ⁶⁵ and Ag_2Cr ⁶⁹ could be synthesized (Figure 5). (The photochemistry of the dimers, Cu_2 and Ag_2 is discussed in section IVC.) The development of photoaggregation introduced a significant element of control in the difficult process of studying specific metal clusters. In addition, it is clearly related to the photochemical insertion reactions discussed above.

More detailed studies of the mechanism of photoaggregation of Ag atoms,^{70,3} show that the ground ^2S state of Ag is not perturbed substantially by the matrix cage, but that the excited ^2P state interacts with its 12 neighboring rare-gas atoms. Vibrational relaxation of the $\text{Ag}(^2\text{P})[\text{R}_{12}]$ complex ($\text{R} = \text{Ar}, \text{Kr}, \text{Xe}$) and fluorescence follow the absorption process, leading to

TABLE I. Photochemical Atom Sources

atom (E)	electronic state	discharge ^a lamp	precursor	byproducts ^b	comments	ref
H	X ² S	Hg	HI/HBr	I/Br		76
	X ² S	Hg	H ₂ S	SH, S		76
	X ² S	H ₂	H ₂ O	O, O ₂ , OH		77
	X ² S	H ₂	HCl	Cl		77
	X ² S	H ₂	CH ₄	CH ₃ , CH, C		77
	X ² S	H ₂	NH ₃	NH ₂ , NH		78
	X ² S	Hg	H ₂ /Cu	CuH	photosensitization by Cu	50
C	X ³ P, 2 ¹ D, 2 ¹ S	Xe	C ₃ O ₂	CCO, CO	via CC	79
	X ³ P	Hg	N ₃ CN	NCN, CNN, CN, N, N ₂	via NCN	79
	X ³ P?	H ₂	CH ₄	CH, CH ₃ , H		77
N	?	H ₂	HN ₃	N ₂ H ₂ , NH, N ₂ , N ₃ ?	via NH	80
	2 ² D	Xe or H ₂	N ₂ O	O, N ₂ , NO, O ₂ , <i>cis</i> -(NO) ₂		81
O	2 ² D	Hg	N ₃ CN	NCN, CN, C ₂ , N ₂	via C + CNN	79
	X ³ P + 2 ¹ D	Hg	O ₃	O ₂	thresholds in gas ~600 nm for ³ P, 308 nm for ¹ D	82
	2 ¹ D + 2 ¹ S	Xe or H ₂	N ₂ O	N, N ₂ , NO, <i>cis</i> -(NO) ₂ ?	matrix threshold for ¹ S: 154 nm	81, 83-85
	2 ¹ D	H ₂	H ₂ O	H, OH		86
	X ³ P, 2 ¹ S, 2 ¹ D	H ₂	O ₂		matrix threshold for ¹ S: 133 nm	83, 87
	2 ¹ D + 2 ¹ S	Xe	CO ₂	O ₂ , CO	gas threshold for ³ P + ¹ D: 176 nm	
	X ³ P	Hg	<i>cis</i> -(NO) ₂	N ₂ O, NO ₂ , N ₂ O ₃	gas thresholds: ¹ D: 167 nm; ¹ S: 129 nm	83, 88
	?	Hg	O ₂	CO ₂ , oxo complexes	threshold 320 nm	89
	?	Hg	CO ₂ or N ₂ O	oxo complexes	sensitized by M(CO) ₆	90
	?	Hg	CO ₂ or N ₂ O	oxo complexes	sensitized by M(CO) ₆	90
F	X ² P	Hg	F ₂			91
	X ² P	Hg	<i>trans</i> -N ₂ F ₂	?		92
	X ² P	Hg	NF ₂	NF, N ₂ F ₄		92
	X ² P	Hg	OF ₂	OF		92
Si	?	H ₂	SiH ₄	SiH _n (n = 1-3)		93
	?	H ₂	PH ₃	PH, PH ₂		94
S	X ³ P(?)	Hg	H ₂ S	SH, H	via SH	95
	X ³ P + 3 ¹ D	Hg	OCS	CO		96
	X ³ P, 3 ¹ S, 3 ¹ D	Xe	OCS	CO	matrix threshold for ¹ S: 173 nm	85, 97
	X ³ P	Xe	CS ₂	CS, CS ₂ ⁺		59, 97, 98
Cl	X ² P	Hg	Cl ₂			99
	X ² P	H ₂	HCl	H		77

^a Photon energies are as follows: H₂ discharge 10.2 eV, Xe discharge 8.4 eV, Hg discharge usually ≤4.88 eV. ^b Other than E₂.

"hot" ground-state Ag atoms which diffuse to form Ag₂ and Ag₃ (see Figure 6). Evidence for this model comes from the width and the massive red shifts of the emission bands relative to the absorption bands, together with the great sensitivity of the emission maximum to the matrix material. Thus the dominant fluorescence band in Xe is located at 550 nm, is 1790 cm⁻¹ wide, and is excited by absorptions in the 322-337-nm range. Ozin et al. argue that the efficiency of this relaxation process is enhanced by the Jahn-Teller effect operating in the Ag(²P)R₁₂ excited state.⁷⁰ In summary, it is the difference in equilibrium Ag-R distance between the ground state and in the exciplex which channels the photon energy into Ag atom translation.

Similar studies of Cu and Cu₂ show that excitation of Cu atoms induces fluorescence of Cu₂, suggesting reactions of excited Cu(²D) with ground-state atoms to form Cu₂. The Cu(²D) atoms are thought to be mobilized by heating from the Cu(²P → ²D) nonradiative transition,⁶⁶ a significantly different mechanism from that described above for silver photoaggregation. The reactivity of Cu*(CH₄)₁₂ exciplex is thought to be the key to formation of Cu(CH₃)H. It is notable that the methane matrices quench the atomic fluorescence.

III. Photochemical Generation of Atoms In Matrices: Sources

In many matrix isolation experiments a molecular

precursor is condensed with a substrate and excess of noble gas. Photolysis of the precursor generates atoms which then react with themselves or with the substrate to form new molecules. Alternatively, the atoms are generated in a less inert host with which they react directly. This method is important for the generation of non-metal atoms, particularly for H and those in the first period. Its competitor, the method of discharging gases (e.g., Cl₂) is more popular for generating Cl, Br, and I atoms (see below). Some sources and reactions of non-metal atoms in fluid phases will be found elsewhere.⁷¹⁻⁷⁵

This section is not concerned with listing all reactions in which atoms are generated, but in choosing suitable precursors in atom-transfer reactions. The ideal precursor molecule would be small and only perturb other species weakly. It would be dissociated by low-energy irradiation to produce the requisite atom and the minimum number of unreactive byproducts. Various sources of atoms are listed in Table I together with the appropriate light source and byproducts (see ref 50, 76-99). Although none of them fulfils all of the requirements above, sources are available for all first-row atoms except boron, and for all second-row non-metal atoms. In choosing the precursor, a compromise is usually needed between a molecule which requires near UV or visible irradiation and gives a reactive byproduct in the cage (e.g., O₃ or N₃CN), and one which requires VUV irradiation and gives an unreactive byproduct (e.g., N₂O). Many of the sources of N, O, and S give

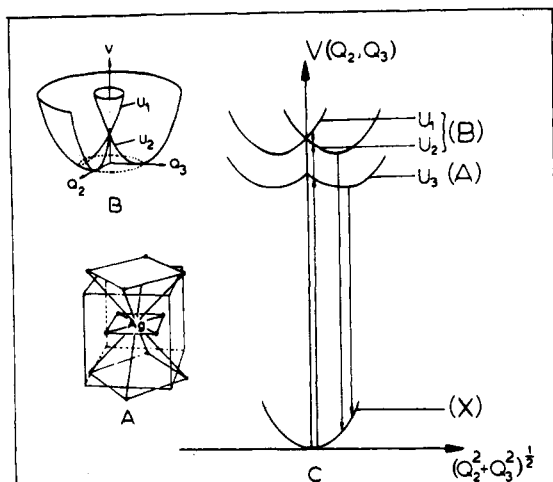

Figure 6. (A) Representation of a Ag atom in a substitutional site of f.c.c. lattice with D_{4h} symmetry. (B) Schematic potential energy surface for a doubly degenerate electronic state (in O_h symmetry) interacting with a doubly degenerate vibrational mode with components Q_2 and Q_3 . (C) Schematic representation of the ground- and excited-state potential energy surfaces for AgR_{12} ($R = Ar, Kr, Xe$), illustrating absorption and emission processes. Reproduced with permission from ref 70. Copyright 1980, American Chemical Society.

rise to electronically excited atoms, so allowing a greater range of reactions. However, until very recently, the relative yield of excited atoms was quite unknown. In this context the excitation spectra measured by Taylor et al.^{83,85,87} using a synchrotron VUV source represent a considerable breakthrough (Figure 7a); their threshold measurements are indicated in Table I. I hope that their work will soon be extended to other sources.

Meanwhile we must rely on data measured in other phases. Ozone absorbs in the regions $\lambda > 450$ and $\lambda < 350$ nm reaching a very intense maximum in the Hartley band at 255 nm.¹⁰⁰ De More and Raper¹⁰¹ measured the yield of N_2O on photolysis of ozone in liquid nitrogen and obtained quantum yields for $O(^1D)$ of .14-.16 between 248 and 300 nm with a sharp falloff at longer wavelengths. Yields close to unity have been obtained in the gas phase¹⁰² with a cutoff for $O(^1D)$ production at 308 nm. More recent work has demonstrated that the quantum yield is temperature dependent.¹⁰³ matrix photochemists beware!

Nitrogen(I) oxide, N_2O , shows peaks in its absorption spectrum at 290, 273, 182, 146, and 128 nm.¹⁰⁴ Photolysis of N_2O in the gas phase can yield $O(^1D)$, $O(^1S)$, $N(^2D)$, and $N_2(A^3\Sigma_u^+)$. At 214 nm and "perhaps" over the entire range 180-230 nm, the only primary product is $O(^1D)$.¹⁰⁵ The yields of other products over the wavelength range 110-150 nm are summarized in Figure 7b.¹⁰⁶

Carbonyl sulfide, OCS , exhibits an absorption maximum in the UV at 222.5 nm in the gas phase with an onset at ~ 255 nm. Further structured bands in the VUV peak at 167 and 153 nm. Photolysis at 254 or 229 nm yields S atoms with quantum yields of 0.67 (1D) and 0.24 (3P) (gas phase).¹⁰⁷ The results of Taylor et al. in matrices yield an onset for S (1S) production at 173 nm and a maximum around 145-165 nm.⁸⁵

Carbon dioxide shows a weak continuum between 140 and 180 nm and is photolyzed by 124- and 147-nm radiation to give CO and excited oxygen atoms. The thresholds for generation of $O(^1D)$ and $O(^1S)$ are 165 and 127 nm, respectively.¹⁰⁸

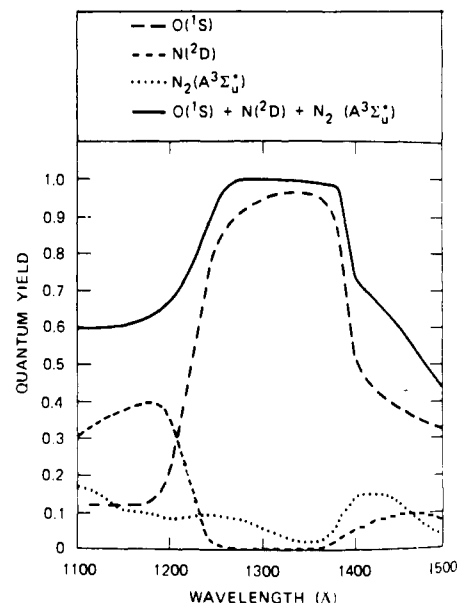
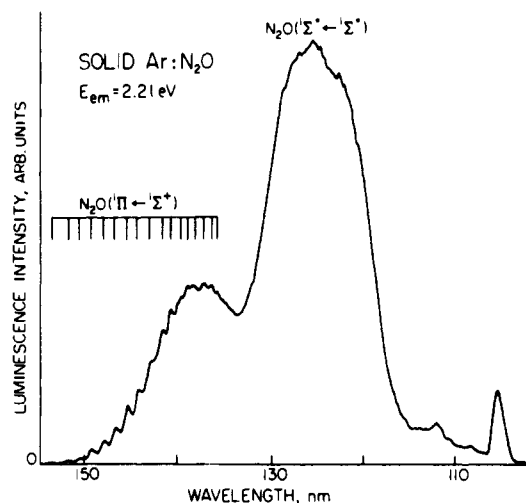

Figure 7. (Above) Photoluminescence excitation spectrum of solid $Ar:N_2O$ (1%) at 4 K obtained by detection of emission of $ArO(E^1\Sigma^+ \rightarrow B^1\Sigma^+)$ at 560 nm; i.e., excitation spectrum for $O(^1S)$ production from N_2O . The sharp band at 105.4 nm corresponds to the onset of exciton absorption by argon. Reproduced with permission from ref 85 (Copyright 1980, American Institute of Physics.) (Below) Quantum yields of $O(^1S)$, $N(^2D)$, and $N_2(A^3\Sigma_u^+)$ from N_2O in the gas phase. Reproduced with permission from ref 106. (Copyright 1975, American Institute of Physics.)

Water absorbs continuously from 125 to 186 nm with maxima at 166 and ca. 130 nm. The threshold for generation of $O(^1D)$ is 161 nm.¹⁰⁸

The dimer of nitric oxide, *cis*-(NO)₂, may also act as a photochemical source of $O(X^3P)$ when irradiated in its UV absorption.⁸⁹ The onset for conspicuous absorption is 240 nm but the photochemical threshold is at ~ 320 nm.

It will be noticed that the matrix threshold for generation of $S(^1D)$ lies to higher energy than the gas-phase threshold. The reverse situation, a lower energy threshold in the matrix, constitutes *photosensitization*. Thus 8.4-eV photolysis of CO_2 in Ar leads to emission from $CO(a^3\pi)$ (gas threshold 11.45 eV) and $O(^1S)$ (gas threshold 9.64 eV).^{83,88} The mechanism of this sensitization is thought to involve a complex between the rare gas (Ar or Kr but not Ne) and $O(^1D)$. This complex has a lifetime long enough for a second photon to be

absorbed. On the other hand, the threshold for *direct* excitation of CO₂ to generate O(¹S) is 10.6 eV as in the gas phase.⁸³

Oxygen-atom transfer from N₂O or from CO₂ to coordinated CO can also be effected using 314-nm photons via absorption by W(CO)₆.⁹⁰ Similarly, photolysis of W(CO)₆ in O₂ doped N₂ matrices yields, inter alia, N₂O. The metal-containing products of these reactions are oxo carbonyl complexes and binary metal oxides.⁹⁰ It may be objected that there is no proof in this case that free oxygen atoms are generated. However, in the case of the photolysis of Cu/H₂/Ar matrices with wavelength of 310 nm (eq 15), the atomic hydrogen has been detected by ESR.⁵⁰

IV. Photochemical Generation of Atoms in Matrices: Detection

In the previous section I have summarized convenient photochemical sources of atoms. It is clearly important, if not essential, that the atoms should be detected. Although this seems a truism, it has often been neglected in photochemical studies of more complex systems which are thought to involve atom production. ESR, UV/vis absorption spectroscopy, and UV/vis emission can be used to detect the atoms themselves. Addition of species to the matrix such as CO, N₂, or Xe allows reaction with the atoms to form molecular species which may be detected by IR or UV/vis absorption or by Raman scattering. Alternatively they may be detected by UV/vis absorption or emission as they dimerize. Each of these methods of detecting the photochemically generated atoms will be treated in turn.

A. ESR

Kasai's experiments^{27,28} using photolysis of Na atoms (section IIA) show clearly how ESR can be used to follow the photochemical generation of H atoms. In other examples from these experiments (e.g., Cd + HI → Cd⁺ + H + I⁻) it is the atoms which are ESR silent while the ions show characteristic spectra. H atoms are detected incidentally in many photochemical experiments (see, e.g., ref 50, 109) but the spectra of photochemically generated H atoms in Kr and Xe matrices are of particular interest.¹¹⁰⁻¹¹² The most detailed studies¹¹¹ show anisotropic hyperfine coupling between H (or D) atoms occupying an octahedral site and their six rare-gas neighbors (Figure 8). The *g* values are marginally lower than free spin and, together with the hyperfine coupling, are slightly altered by ²H substitution. These parameters are interpreted in terms of a H...R bonding interaction in the HR₆ (R = Kr, Xe) "molecule". The effects of ²H substitution arise via changes in the amplitudes of vibration of the molecule. However, it has also been suggested that the spectra arise from dynamic averaging of short-lived XeH molecules.⁹⁶

Fluorine and chlorine atoms also interact with rare-gas atoms to form complexes,¹¹³ which may be detected by ESR (see section IVD1). Detection of other atoms generated photochemically in matrices is rare. Morehouse et al.¹¹⁴ detected P and As atoms following γ -radiolysis of PH₃ and AsH₃ in Kr. However, they should also be detectable following VUV irradiation. Iodine atoms have been detected following photolysis of HI in Xe.¹¹⁵

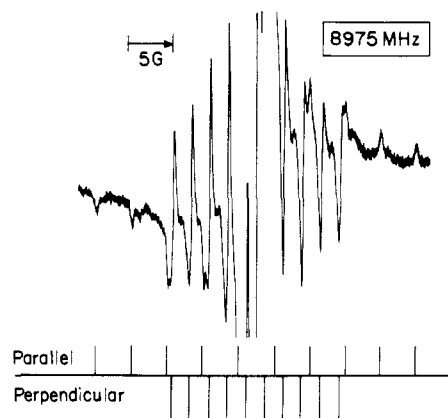

Figure 8. The high-field ($m_I = -1/2$) transition of the ESR spectrum of H atoms in Kr at 10 K, showing hyperfine structure from ⁸³Kr ($I = 9/2$, 11.6%) in natural abundance. Reproduced with permission from ref 111. Copyright 1979, American Institute of Physics.

B. UV/Visible Absorption

None of the atoms listed in Table I absorbs in the region $\lambda > 200$ nm. However, absorption spectra of matrix-isolated transition metals have been investigated extensively.^{3,18} Occasionally transition-metal atoms may be generated photochemically, as in the production of atomic iron by photolysis of Fe(CO)₅ in N₂.⁴⁰ The photoinduced aggregation of metal atoms was discussed in section IIC. Ozin et al.⁶⁶ have investigated the photodissociation of Cu₂ and Ag₂ in Ar and Kr using selective irradiation, the reverse of photoaggregation. The decay of Ag₂ and growth of absorption due to Ag is monitored by absorption spectroscopy following irradiation at 390 nm into the $5s\sigma_g \rightarrow 5s\sigma_u$ bonding to antibonding transition. The photodissociation of MH₂ and M(CH₃)H (M = Fe, Mn) to form atoms has also been monitored by UV/vis absorption (eq 3).^{7,48}

C. UV/Visible Emission

The VUV photolysis of OCS and N₂O gives rise to electronically excited atoms which can be detected directly by their visible emission. Thus, the S(3¹S) atoms generated on photolysis of OCS (eq 16) can be

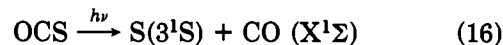

detected by their emission at 775 nm (¹S → ¹D)¹¹⁶ and at 465 nm (¹S → X³P).⁹⁷ N₂O can dissociate to give either O or N atoms:

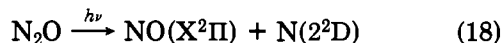
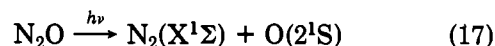

The oxygen atoms can be detected during photolysis by their emission at 560 nm (¹S → ¹D) while the nitrogen atoms emit at 521 nm (²D → X⁴S).^{85,117,118} As has already been mentioned, excitation spectra are now available for S(¹S) and O(¹S) in these reactions.^{83,85} The O(¹S → ¹D) emission is also observed on photolysis of CO₂ in all rare-gas matrices,^{83,88} but O(¹D → X³P) at 634 nm can be detected only in Ne matrices.⁸⁸ The presence of O(¹D) has been confirmed by monitoring the 634-nm emission while scanning the visible spectrum with a tunable laser. The emission intensity falls as the laser passes through the O(¹S) → O(¹D) absorption at 563

nm.⁸⁸ In an intriguing experiment Krogh et al. report $N(^2D \rightarrow ^4S)$ emission during warmup of a photolyzed N_3CN/Ar matrix.⁷⁹ They postulate that $N(^2D)$ may derive from decomposition of a metastable isomer of N_3 . However, N_3 remains unobserved by IR matrix isolation methods.

Excitation of Cu_2 at 400 nm in Ar matrices results in $^2D_{3/2} \rightarrow ^2S_{1/2}$ emission from Cu atoms; in Ne, Kr, and Xe matrices $^2D_{5/2} \rightarrow ^2S_{1/2}$ emission is observed in addition.^{86,119}

Little is known of the lifetimes of these excited atoms in matrices. However, Tinti and Robinson have measured the decay of the $N(^2D \rightarrow ^4S)$ emission following generation of N atoms by X irradiation of matrices.¹²⁰ The times are Kr ~ 7 s, Ar 18 s, N_2 41 s, Ne 340 s compared to 12 h in the gas phase. (The decay is not purely exponential.) The decay time of $O(^1S \rightarrow ^1D)$ measured following electron bombardment in solid N_2 is also nonexponential and is approximately 130–240 μs ¹²¹ (cf. 0.7 s in the gas phase). The decay times for the same transition in Ar doped with 1% N_2O or 1% CO_2 have been reported as 40 μs and 2.4 μs .^{83,85} However, Fournier et al., who used matrices with 0.1% CO_2 obtained a lifetime of 560 ms.⁸⁸ Their value for the $O(^1D \rightarrow ^3P)$ transition in Ne was 32 s compared to 150 s for the gas phase.⁸⁸ It is well established that the concentration has a drastic effect on the rate of energy transfer, so these two measurements are not necessarily inconsistent. Fournier's measurements establish that the lifetime of these forbidden transitions may be reduced by less than a factor of 10 relative to the gas phase if the matrix is sufficiently dilute.

The emission of the atoms is closely related to that of the complexes XeO , XeF , etc. which are discussed in section IVD2 below.

D. Reaction To Generate Molecular Species

(1) **IR, Raman, and ESR Spectra of Products of Reaction with CO, N_2 , Xe, etc.** The methods of detecting non-metal atoms which have been described above are unsuitable for those who are equipped only for absorption spectroscopy. An alternative method which is often more convenient, if less direct, involves doping the matrix with CO, N_2 , CO_2 , O_2 , or Xe or using one of these species as the matrix. The reaction products may then be detected by IR or UV/vis absorption spectroscopy. CO reacts with H, Cl, and all first-period non-metal atoms, N_2 reacts with C to give NCN and CNN, and with O to give N_2O . CO_2 reacts with oxygen atoms to give the CO_3 radical. The species XeF , $XeCl$, and XeO may be detected by UV/vis absorption or emission (section IVD2) while XeF_2 may be detected by IR and Raman spectroscopy. The most convenient method of detecting ground-state S atoms is probably to dope the matrix with about 0.5–1% O_2 and to look for SO_2 by IR absorption^{116b} or UV emission spectroscopy (see section IVD2). The IR absorption wavenumbers for relevant triatomics will be found in ref 89, 92, and 124–135 and in Table II.

A number of these species (e.g. HCO, HO_2 , ClCO) are also suitable for testing for atom production by ESR (see section IVA).^{122,123} Curiously, there seems to be no record of the ESR spectra of KrF and XeF in matrices although they are well established in crystals (see ref 113). When fluorine atoms are generated photochem-

TABLE II. Wavenumbers for Fundamental Vibrations of Molecular Species Used for Atom Detection

substrate	product	ν_1	ν_2	ν_3	matrix	ref	
CO	HCO	2483	1087	1863	Ar	124, 125	
	DCO	1926	850	1803	Ar	124, 125	
	CCO	1074	381	1978	Ar	126	
	NCO	(1275)	489	1938	CO	127	
	OCO		662	2342	Ar	82	
	FCO	1018	626	1855	CO	92, 128	
	ClCO	570	281	1880	CO	129	
	N_2	NCN		423	1478	N_2	130
		CNN	1252	394	2858	N_2	130, 131
NNN		1290	589	2236	N_2	132	
Xe	FXeF	512	215	549	Ar	133	
	O_2	OSO	1148	518	1352	Ar ^a	82, 134
		1153	520	1356	Ar ^a		
HOO		3414	1389	1101	Ar	135	
DOO		2530	1020	(1106)	Ar	135	

^a The two sets of frequencies arise from matrix splittings.

ically from CF_3OF in solid Kr, a spectrum is obtained showing coupling to two Kr nuclei.¹¹³ The linear $KrFKr$ molecule has substantial spin density in the $Kr(4p)$ orbitals ($\sim 12\%$ each) and g_{\perp} deviates considerably from free spin ($g_{\parallel} = 2.0006$, $g_{\perp} = 2.0657$). The species Kr_2F has also been observed in emission in the gas phase at high Kr pressures, but matrix emission has not been recorded.¹³⁶ The ESR spectrum of $XeCl$ has been recorded following photolysis of $Ar/Cl_2/Xe$ matrices.¹¹³

A major factor which limits the sensitivity of these reactions in detecting atoms, is photodissociation. HCO is dissociated by visible light ($\lambda > 400$ nm)^{77b,122,125} as is CCO ,¹²⁶ while NCO, NCN, FCO, and HO_2 are dissociated by UV irradiation ($\lambda < 280$ nm).^{122,127,130,131} If the wavelengths of light which dissociate these species cannot be avoided in generating the atoms, it is necessary to use high concentrations of CO or N_2 dopant ($>10\%$). Other species which are photostable (e.g., SO_2 or XeF_2) may be detected with 1% or less dopant added to an argon matrix.

Although Jones and Taube⁸² argued that the CO_2 observed in their experiments with $OCS + O_3$ in Ar did not arise from reaction of $CO + O$, other experiments suggest that this reaction is readily observed.^{90,137} The observation of a broad emission band by Fournier et al.,¹¹⁸ attributed to excited CO_2 generated from $O(^3P) + CO$, confirms that this should indeed be a useful test. Reaction with N_2 to form N_2O ¹³² or with CO_2 to form CO_3 could be used as a test for production of $O(^1D)$.¹³⁸ Another characteristic reaction of $O(^1D)$ in fluid phases, the insertion into alkanes, does not seem to have been investigated in matrices at all, although the reaction with CH_4 to give CH_3OH and CH_2O ¹³⁹ seems suitable for matrix application. Further experimental distinctions between ground- and excited-state oxygen atoms are indicated in Table III and section VC5.

As mentioned above, ground-state sulfur atoms may be detected by their reaction with O_2 . Sulfur atoms in the excited 1D state insert characteristically into alkanes.⁷⁴ This reaction has recently been observed in the matrix by photolyzing OCS in CH_4 matrices to generate CH_3SH .¹³⁷

It is appropriate to conclude this section by an example of the application of this method in mechanistic photochemistry. Photolysis of $(\eta-C_5H_5)_2WH_2$ in argon results in production of $(\eta-C_5H_5)_2W$, but this experiment does not show whether the hydrogen atoms dissociate sequentially or together. Photolysis in a CO

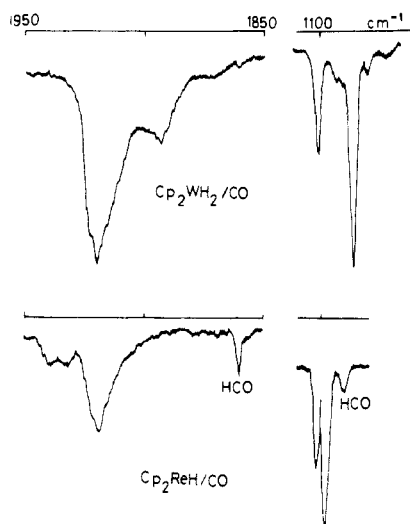

Figure 9. IR spectra obtained on photolysis of $(\eta\text{-C}_5\text{H}_5)_2\text{WH}_2$ (above) and $(\eta\text{-C}_5\text{H}_5)_2\text{ReH}$ (below) in CO matrices at 12 K showing production of HCO for the monohydride only.

matrix still causes production of $(\eta\text{-C}_5\text{H}_5)_2\text{W}$ but no HCO is detected.⁵¹ However, photolysis of $(\eta\text{-C}_5\text{H}_5)_2\text{ReH}$ in CO does result in HCO production (Figure 9).¹⁴⁰ The implication of these experiments is that H_2 dissociates from $(\eta\text{-C}_5\text{H}_5)_2\text{WH}_2$ in a single step.

(2) UV/Vis Absorption and Emission Spectra of Products of Dimerization and Other Reactions.

Many of the products of reaction of atoms with CO, N_2 , etc. absorb in the UV/visible: this section will not deal with their spectra, reference to which may be found in Table I. Here I am concerned with two special cases: the absorption and emission from diatomics, e.g., S_2 , and from rare gas halides, oxides, and sulfides. Additionally I will discuss luminescence of SO_2 in this section because of its close similarity to S_2 .

Diffusion of photochemically generated atoms leads to the formation of homonuclear diatomics. In the case of N, O, and S recombination of atoms leads to electronically excited diatomics which decay to the ground state radiatively. Emission from N_2 (Vegard-Kaplan bands) is observed during photolysis of N_2O .¹¹⁸ Emission from C_2 ,⁷⁹ O_2 ,^{88,95,118,141} and S_2 ⁹⁵⁻⁹⁷ is observed when matrices containing the corresponding atoms are warmed above 10 K (thermoluminescence, Figure 10a):

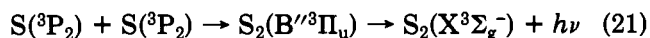
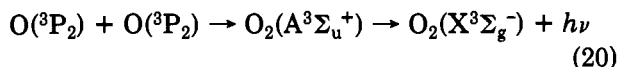
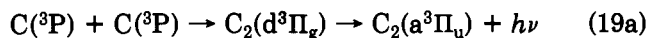
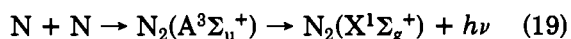

Since N_2 emission is observed during photolysis the recombining atoms may be in an excited state, but the slow thermoluminescence of O_2 and S_2 is only compatible with recombination of ground-state atoms. Although the emission of S_2 was originally assigned to the $\text{B}^3\Sigma_u^- \rightarrow \text{X}^3\Sigma_g^-$ transition, Bondybey and English¹⁴² have reassigned the spectrum to $\text{B}^{\prime\prime 3}\Pi_u \rightarrow \text{X}^3\Sigma_g^-$ on the basis of laser excited fluorescence experiments and correlation arguments. Their measurements indicate a much longer lifetime for the emitting state than is found for the $\text{B}^3\Sigma_u^-$ state in the gas phase. These au-

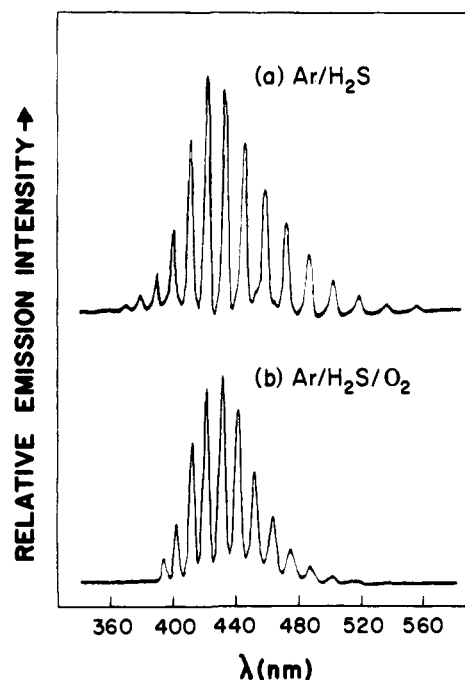
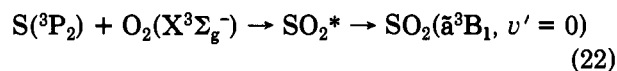

Figure 10. Comparison of thermoluminescence spectra of separate argon matrices photolyzed with near UV radiation during deposition: (a) $\text{Ar}/\text{H}_2\text{S} = 100$, 13 K; (b) $\text{Ar}/\text{H}_2\text{S}/\text{O}_2 = 100/1/1$, 18 K. Spectrum a is due to S_2 emission, spectrum b is due to SO_2 emission. Reproduced with permission from ref 95. Copyright 1978, American Institute of Physics.

thors¹⁴² have used laser excitation to predissociate S_2 and follow the in-cage recombination and subsequent emission. They have reached the conclusion that the emitting state in Ne and Ar is long-lived and arises from $\text{B}^{\prime\prime 3}\Pi_u$. The emitting state in Kr and Xe has one-tenth the lifetime and is $\text{B}^3\Sigma_u^-$. The thermoluminescence seems to involve the same transition in Ar, Kr, and Xe.⁹⁵

Not only can the emitting states of S_2 be easily confused, but the thermoluminescence of S_2 closely resembles a much more intense thermoluminescence observed when the matrices are doped with O_2 (<1% is sufficient). The emission arises from formation of electronically excited SO_2 (Figure 10b):



The two spectra are best distinguished in their outer, weaker bands. The dominance of SO_2 emission during warmup is explained not only by the intensity of emission, but also by $\text{S}_2 \rightarrow \text{SO}_2$ energy transfer.^{116b}

While N_2 , O_2 , and S_2 have been observed in emission, Si_2 ⁹⁸ and P_2 ⁹⁴ have been observed in absorption following photochemical generation of the atoms. Generation of F_2 , S_2 , or C_2 could also be monitored in this way. Diatomic metals generated by photoaggregation have been detected both by UV/vis absorption and by fluorescence methods.^{3,63-70}

An alternative method of studying halogen, oxygen, and sulfur production which is less dependent on diffusion is to study the absorption or emission from rare gas complexes RX ($\text{X} = \text{F}, \text{Cl}, \text{Br}, \text{O}, \text{S}$). These remarkable molecules are more strongly bound in their excited states than their ground states and are used in excimer (more correctly, exciplex) lasers. XeX ($\text{X} =$

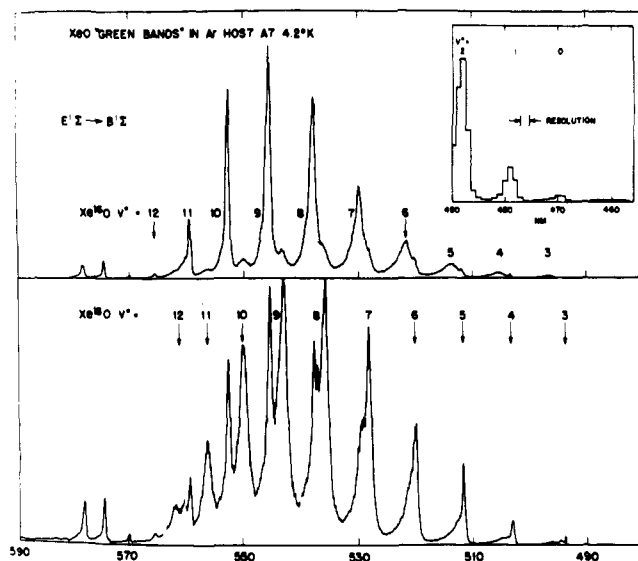

Figure 11. Visible emission following 220 nm excitation of XeO samples made by depositing products of microwave discharge of Xe/O₂/Ar (1/4/2000) mixtures or by UV photolysis of Xe/Ar mixtures containing traces of H₂O. Upper spectrum ¹⁶O/¹⁸O = 19/1, lower spectrum ¹⁶O/¹⁸O = 1/3. Insert is a signal-averaged spectrum in the blue region of very weak emission. Reproduced with permission from ref 86. Copyright 1977, American Institute of Physics.

F, Cl, Br) and KrF can be detected by their UV absorption¹⁴³ when Ar or Ne matrices are doped with ~1% Xe or Kr. Alternatively they may be detected by their UV-excited emission spectra.^{143,144} These experiments have demonstrated that XeF in Ne is bound by $D_e = 1495 \text{ cm}^{-1}$ with $\omega_e = 247 \text{ cm}^{-1}$ and $\omega_e X_e = 10.2 \text{ cm}^{-1}$ in its ground state, only very slightly greater values than in the gas phase. The B and D states have $\omega_e = 280 \text{ cm}^{-1}$ and 316 cm^{-1} , respectively (in Ar), appreciably less than in the gas phase in accord with an ionic model resembling Cs⁺F⁻. Further information about these molecules has come from ESR (see above)^{113,145} and magnetic circular dichroism.¹⁴⁶

XeO can be observed in absorption or emission (Figure 11)^{84,86,147} while RO (R = Ar, Kr)^{83,85,87,88} and RS (R = Ar, Kr, Xe)¹⁴⁸ are detectable only in emission. The bonding in XeO presents a significantly different case from XeF since there are several excited states correlating with Xe (X¹S) and singlet oxygen below the charge-transfer states. The most strongly bound of these is the B¹Σ state which has $\omega_e \approx 350 \text{ cm}^{-1}$ and is at least 12 vibrational quanta deep. Not only do these experiments give crucial information about the bonding in these diatomics but they can also be used to obtain excitation spectra for O(¹S) and S(¹S) production.^{83,85,87,88} The lack of molecular emission peaks for ArO and KrO in Fournier's spectra⁸⁸ is partly explained by the lower excitation energy used than by Taylor et al.⁸³ Nevertheless the differences between ref 83 and 88 suggest that synchrotron experiments at high dilution of CO₂ or N₂O in Ar or Kr are needed.

In this section I have shown that photochemically generated atoms can be detected in many ways, yielding fascinating information about their generation and reactions and about the properties of the reaction products. As an alternative to the classification by method used above, Table III summarizes the methods of detecting *excited* atoms generated photochemically (see section VC5). As more photodissociation experiments

TABLE III. Specific Detection of Excited Atoms (References in Text)

atom	atomic emission	reaction with detection by IR or UV/vis absorption	molecular emission
N(² D)	yes (² D → ⁴ S)	?	?
O(¹ D)	(¹ D → ³ P) neon matrix only	+N ₂ → N ₂ O +CO ₂ → CO ₃	indirect evidence for RO(¹ D) (R = Ar, Kr)
O(¹ S)	yes (¹ S → ¹ D)	?	+R → RO* (R = Ar, Kr, Xe)
S(¹ D)	no	+CH ₄ → CH ₃ SH	+R → RS* (R = Ar, Kr, Xe)
S(¹ S)	yes (¹ S → ¹ D)	?	?

are conducted it is important that the established results should be used for the detection of ejected atoms and that investigations should not rely entirely on detection of molecular fragments.

V. Synthesis in Matrices Using Photochemical Atom Sources

The methods of generating atoms photochemically and of detecting them have been summarized in sections III and IV. The synthesis of unstable molecules in matrices may be effected, inter alia, by (a) atomic photoelimination leaving a molecular fragment, R, or (b) by transfer of a photogenerated atom, X, to another species in the matrix:

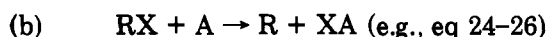
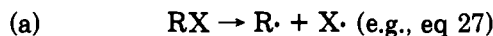

The nature of the fragments produced by atomic photoelimination will be discussed in the succeeding review.²⁵ The reader's attention is drawn to section IV of the succeeding review which includes molecular-transfer reactions such as the oxidative addition of F₂. In this section I will concentrate on atom-transfer reactions, including a discussion of experimental details and a survey of reactions emphasizing more recent applications.

A. Matrix Ratios and General Principles

The principles of synthesis using photochemical atom sources may be illustrated by experiments of Ault, Howard, and Andrews on xenon fluorides. A mixture of Ar, Xe, and F₂ in ratios varying from 100:1:1 to 5000:1:1 was deposited and photolyzed in the 230–350-nm region.¹³³ XeF₂ was detected by IR absorption and Raman scattering, and XeF by UV/vis absorption and emission¹⁴² studies. In experiments using triple mixtures, it is usual to employ matrix ratios of about 1% for one minor component and 0.1–1% for the other. Lower concentrations, although desirable for good isolation, reduce the probability of atom transfer. This is illustrated by Andrews'¹⁴³ experiments in which the emission intensity decreased by a factor of 3000 over the 50-fold change in matrix ratios. Since the rate of diffusion of heavier atoms decreases substantially, it is common to employ photolysis during deposition for second-row atoms. Ault and Andrews used this technique to generate XeCl and XeBr. Generation of halogen atoms is a relatively clean process: in their search for the IR fundamental of XeF, the only species

observed were XeF_2 and SiF_4 .¹³³

Some of Milligan and Jacox's early experiments illustrate the considerable problems when working with sources of C, N, and O. They synthesized NCO by four routes,⁸⁰ together with many other products:

(i) $\text{N} + \text{CO}$ (0.5% HN_3 in CO)

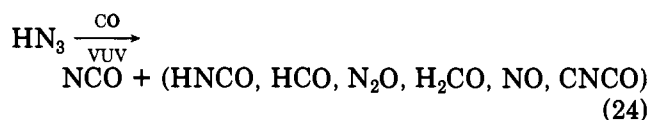

(ii) $\text{C} + \text{NO}$ (0.5% NO + 0.5% N_3CN in Ar)

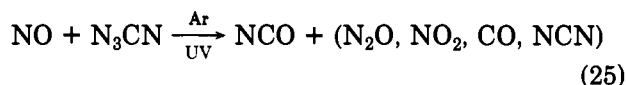

(iii) $\text{O} + \text{CN}$ (0.5% N_2O + 0.5% HCN in Ar)

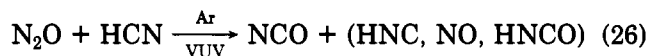

(iv) dissociation of HNCO (0.5% in Ar)

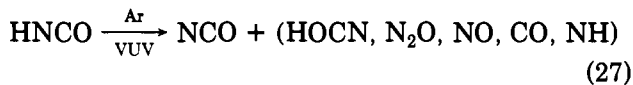

Notice that the use of solid CO in method i helps to overcome the problem of NCO photodissociation. Those who read the references to this and the next review will surely appreciate the enormous contributions made by Milligan and Jacox to the development of matrix isolation and to the study of numerous free radicals.

B. Examples of Photochemical Atom Transfer and Abstraction

The reactions of various atoms will be summarized diagrammatically. The numbers in parentheses refer to the adjacent references. Only a leading reference is given to older work. Reactions of C, N, Si, P, and Cl are covered by previous sections.

(1) **Photochemical Transfer and Abstraction of H Atoms.** The few recorded experiments involving transfer of photochemically generated hydrogen atoms are summarized in Scheme I (for a discussion of rare-gas complexes of H see section IVA, ref 77, 110–112, 122, 124, 125, 149, 150).

Hydrogen and fluorine atoms will also abstract hydrogen atoms. Thus photolysis of Ar/ CH_4 / F_2 matrices results in production of F atoms which react to form $\text{CH}_3\text{F} \cdots \text{HF}$ with almost zero activation energy.¹⁵¹ When HI is photolyzed in solid CH_4 or CH_4 -doped Xe, both CH_3 and H are observed,⁷⁶ the proportion of CH_3 increasing rapidly above 3-eV photon energy.¹⁵² Photolysis of HI in ethane-doped xenon matrices at 4 K results in formation of hydrogen atoms. On annealing to 35–50 K the hydrogen atoms react with ethane to form ethyl radicals which may be detected by ESR.^{152,115} The temperature dependence of the kinetic isotope effect on the abstraction reaction ($k_{\text{H}}/k_{\text{D}} \sim 2$ at 35 K and ~ 60 at 50 K) has been interpreted in terms of a tunneling mechanism. However, formation of ethyl radicals competes with hydrogen abstraction from excess HI. Intriguingly, it seems that the relative efficiency of formation of C_2H_5 can drop with increasing temperature, so Kinugawa et al., working at 77 K, did not see

SCHEME I. Photochemical H Atom Transfer in Matrices^a

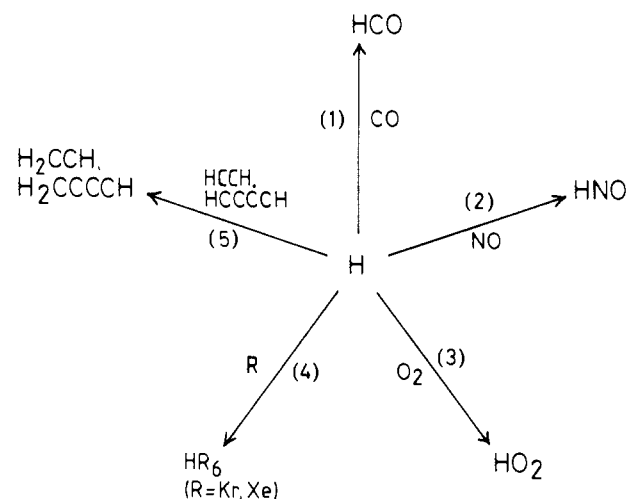

^a Key to references: (1) 76, 77, 122, 124, 125; (2) 149; (3) 76, 122, 135; (4) 110–112; (5) 150.

abstraction of H from $i\text{-C}_4\text{H}_{10}$ by thermal hydrogen atoms, although they did observe abstraction during photolysis.¹¹²

(2) **Photochemical Transfer and Abstraction of O Atoms.** The use of O atoms in synthesis continues to be a source of remarkable species (Scheme II ref 6, 55–58, 80, 84–90, 94, 118, 132, 137, 138, 147, 153–162). XeO was discussed in section IVD2. Larzillière and Jacox⁹⁴ have reported the reactions of PH_3 fragments with O atoms from N_2O to make PO and HPO. Like HNO ,¹⁴⁹ HPO proves to have a very low PH stretching force constant (HNO , $\nu(\text{NH}) = 2717 \text{ cm}^{-1}$; HPO , $\nu(\text{PH}) = 2095 \text{ cm}^{-1}$; cf. NH_3 , $\nu = 3414 \text{ cm}^{-1}$; PH_3 , $\nu = 2421 \text{ cm}^{-1}$; antisymmetric stretching modes). FCIO is a good example of a species synthesized by the O-atom-transfer method,¹⁵⁷ which is unique to matrix isolation. Such syntheses can be established through careful use of isotopic substitution; in this example Andrews et al. demonstrate the method very elegantly.

In the molecule SO_4 , synthesized by photolysis of SO_3 and O_3 in Ar,⁶ we have a species to which matrix isolation probably offers the only satisfactory access. This molecule may be the key intermediate in the photoinduced oxidation of SO_2 by O_2 in the atmosphere and in peroxodisulfate oxidations. However, it could not be synthesized in a matrix by photolysis of SO_2 in an oxygen matrix. Another feature distinguishing the matrix from the gas-phase experiments is the lack of formation of SO_2 from reaction of SO_3 and $\text{O}(^3\text{P})$. The authors make a convincing case for the dioxosulfur peroxide structure for SO_4 and observe $\nu(\text{O}-\text{O})$ at 925 cm^{-1} ($\nu(^{18}\text{O}-^{18}\text{O})$ at 881 cm^{-1}). This structure, reminiscent of $\text{CrO}(\text{O}_2)_2$, should be diamagnetic in accordance with the lack of observed ESR spectrum. An important aspect of this study is the unusually thorough examination of the wavelength dependence of photolysis. The synthesis can be achieved with 578-nm photolysis, below the threshold for $\text{O}(^1\text{D})$ production, or at 254 nm where the primary product in the gas phase would be entirely $\text{O}(^1\text{D})$.^{100,101} Photolysis of N_2O or of SO_3 itself at 185 nm was also effective in providing O atoms for the reaction.

Another example of an ozone reaction which proceeds with long-wavelength photolysis (514.5 nm) and UV

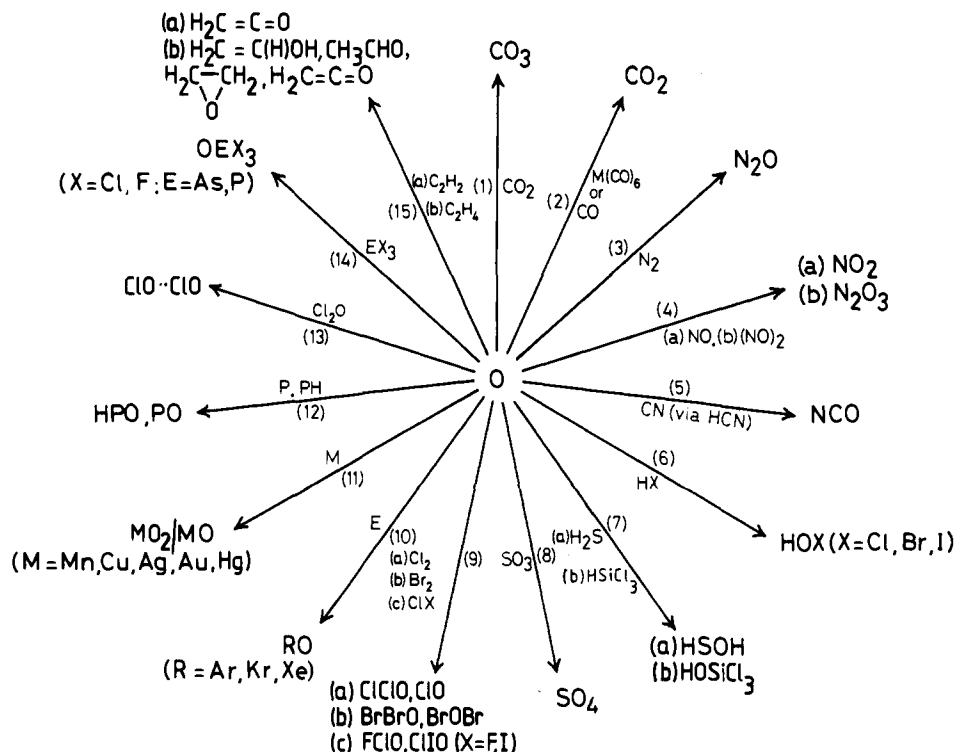
Scheme II. Photochemical O Atom Transfer in Matrices^a

^a Key to references: (1) 89, 90, 138; (2) 118, 137; (3) 118, 132; (4) 90, 153, 154; (5) 80; (6) 132, 155; (7) 156; (8) 6; (9) 157; (10) 84-88, 147; (11) 55-58, 158; (12) 94; (13) 159; (14) 160, 161; (15) 162.

photolysis is its reaction with H_2S .¹⁵⁶ Smardzewski and Lin show convincingly that the product contains one oxygen and two inequivalent H atoms (Figure 12a,b) and assign it as the monosulfur analogue of hydrogen peroxide: HSOH. They suggest that it is formed via a transient species H_2SO .

The reaction of NO with O_3 in matrices to form NO_2 is of particular interest since it proceeds slowly in the *dark* at low temperature. Frei and Pimentel¹⁵⁴ have shown that this reaction involves two first-order processes which are temperature independent but are slowed down by $\sim 20\%$ using $^{18}\text{O}_3$: good evidence for a tunneling reaction. Moreover, IR laser irradiation of the $\text{NO}\cdot\text{O}_3$ pairs at 1874.5 cm^{-1} enhances the reaction by 62%. This enhancement involves single photon absorption and arises by increased reactivity of the vibrationally excited state and not by bulk heating. The role of complexes such as $\text{NO}\cdot\text{O}_3$ in these reactions is discussed more fully in section VC.

The photochemical reaction of matrix-isolated C_2H_4 with O_3 leads to a surprising wealth of products: acetaldehyde, ketene, ethylene oxide, and vinyl alcohol (syn planar conformer) are claimed to be primary products. In addition, methane and acetic acid are formed by secondary reaction of acetaldehyde. There is, as yet, little evidence for the participation of $\text{O}(^1\text{D})$ or for the mechanism of ketene formation.¹⁶²

Reaction of Cu atoms with O_3 in Ar generates CuO_3 and CuO . Photolysis ($\lambda > 300\text{ nm}$) causes an increase of CuO and decrease of CuO_3 . The increase in CuO need not occur by dissociation of O_2 from CuO_3 (see section IIB2). The emission spectrum formerly attributed to $\text{CuO}^{57,58}$ has been reassigned to CuO_2^{56} , following investigations using $^{16}\text{O}^{18}\text{O}$. Some uncertainty must therefore surround the origin of the emission spectra assigned to MnO , AgO , and $\text{AuO}^{57,56}$. In particular, the

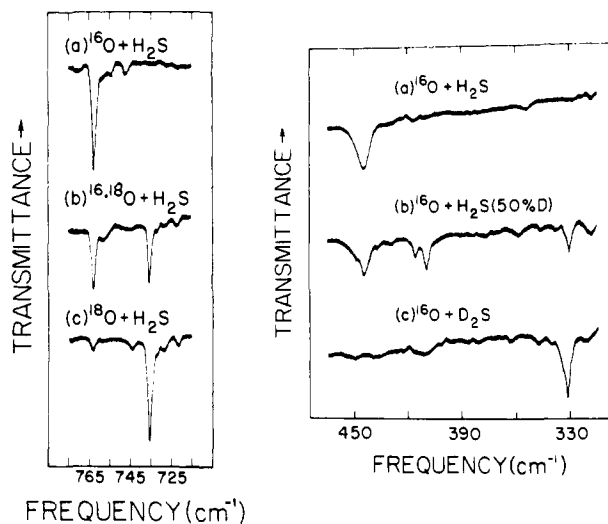
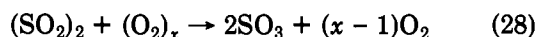

Figure 12. IR spectra of HSOH obtained by photolysis of $\text{H}_2\text{S}/\text{O}_3/\text{Ar}$ (1/1/100-200) mixtures showing (i) ^{16}O and (ii) ^2H isotopic splittings. Isotopic enrichments are indicated on figure. Reproduced with permission from ref 156. Copyright 1977, American Institute of Physics.

differences between gas and matrix spectra of AgO suggest that a reexamination of this system is needed.

Photolysis of metal hexacarbonyls in the presence of O_2 ,⁸⁹ CO_2 , or N_2O^{90} induces oxygen-atom transfer to coordinated CO. Oxygen-atom transfer to the metal is also implied by such products as $\text{OW}(\text{CO})_4$ and WO_3 .⁹⁰ As the photooxidations become more complex, it becomes less useful to describe them as reactions involving transfer of atomic oxygen. The photooxidation of SO_2 in O_2 matrices is best described by the equation ($x \geq 2$).¹⁶³



samples of OCS in Ar above 10 K.⁹⁵⁻⁹⁷ When N₂ matrices containing F atoms and NO from 8 to 21 K¹⁶⁷ are annealed, FON and FNO are formed. Heavier atoms such as Ag and Ni will diffuse at higher temperatures.⁶⁴

Diffusion of atoms during photolysis is more complicated and controversial since it depends on the energy acquired by the atom during reaction and its rate of transfer to the matrix. It also depends on the rate of recombination to form the precursor, i.e., the importance of the cage effect. The difficulty of predicting the outcome is illustrated by the cases of S₂ and Ag₂. Photolysis of S₂ yields S atoms which apparently all recombine within the cage.¹⁴² Surprisingly, photolysis of Ag₂ yields isolated Ag atoms.⁶⁶ The role of excess translational energy of the atom in preventing recombination is discussed further in the context of fluorine-atom elimination in section IIB of the succeeding review. The decreasing ease of diffusion of heavier atoms during photolysis is graphically illustrated by the yields of CN obtained by photolysis of XCN, which decrease in the series X = H > F > Cl > Br > CN.²²

The lack of diffusion of Cl, Br, and I during photolysis and their ready recombination discourages their use in photochemical transfer reactions. Occasionally this is circumvented by photolysis during deposition,¹³³ more frequently by using discharges as atom sources.¹⁷⁸ (but see ref 25, section IIC). Notice that the yield for photochemical halogen atom loss may be sufficient for ESR but not for IR spectroscopy (e.g. the photolysis of propargyl bromide yields a sufficient concentration of propargyl radicals for ESR detection).¹⁵⁰ The rate of energy transfer of excited atoms in matrices is documented in few cases. Bondybey's experiments^{179,180} (see below) indicate that excess thermal energy is rapidly transferred to the matrix, quenching up to 0.8 eV of translational energy with 100% efficiency within <10 ns. On the other hand, Ozin's photoaggregation experiments suggest slow loss of translational or librational energy.⁶⁴⁻⁷⁰

It is not straightforward to distinguish one reaction type from another. However, four features of an atom-transfer reaction involving diffusion of *ground* state atoms should be (i) potentially high conversion of precursor (since it is not just complexed precursor which reacts), (ii) no discrimination between different sources of the atom, (iii) the precursor should be readily photolyzed in the absence of substrate, (iv) further reaction may take place on annealing after photolysis (Table IV). The second feature may be complicated by photosensitivity of the product. Only the longest lived of electronically *excited* atoms will be able to diffuse significantly (e.g., O(1D), see section IVC and VC5 for lifetime data).

The generation of HCO^{77,122,124,125} and FCO^{92,128} occurs with many different H and F atom sources suggesting a diffusion (type a) mechanism. However, weak complex formation (type b) cannot be excluded because the photosensitivity of the products forces the use of high CO concentrations. The reaction of NO with F atoms continues on annealing after photolysis,¹⁶⁷ again suggesting a diffusion mechanism.

(2) Weak Complex Formation. In the second mechanism (type b, Scheme IV) photochemical atom transfer occurs only for substrate-precursor cage pairs, although the substrate and precursor interact weakly.

The reaction may be limited in this way because (a) the atom does not diffuse appreciably, (b) atom transfer must compete with cage recombination, or (c) reaction only occurs with electronically excited atoms which are short-lived. This type of reaction is easier to distinguish than the diffusion type: (i) the overall conversion should be low, since it is limited to precursor-substrate pairs; (ii) there should still be little discrimination between atom sources; (iii) the precursor may not appear to photolyze or may photolyze more slowly in the absence of substrate because of in-cage recombination; (iv) side bands may be observed in the IR spectrum of substrate and precursor; these bands may decrease faster on photolysis than the monomer bands (see Table IV).

Several examples of weak complex formation are known. Photolysis of ClF in Xe-doped Ar yields only ClXeF without XeCl₂ or XeF₂ indicating that no diffusion occurs.¹³³ The photolysis of SO₃/O₃/Ar mixtures is much more effective in generating SO₄ than photolysis of N₂O/SO₃/Ar mixtures, possibly because no suitable complex is formed by N₂O and SO₃.⁶ This example suggests the beginnings of discrimination between atom sources (feature ii). The fourth feature, identification of the substrate-precursor complex itself, may provide the best evidence for the weak complex mechanism. The photolysis of O₃ and AsF₃ in Kr is a well-documented example.¹⁶¹ Sidebands due to O₃...AsF₃ complex are observed both in the As-F stretching region of the IR spectrum (Figure 13) and near the 1034 cm⁻¹ band of O₃. As the ratio of O₃:AsF₃ increases, these extra features become more important (Figure 13a-c), and it is these bands alone which decrease on photolysis (Figure 13d). Another example is the NO·O₃ complex which may be irradiated selectively with an IR laser to form NO₂ (section VB2).¹⁵⁴ As we move towards the formation of stronger complexes more distinct photochemistry is observed, e.g., the photochemistry of dimers such as (CH₂O)₂ and (CH₂N₂)₂ discussed in section IIG of the succeeding review.²⁵

(3) Strong Complex Formation. As the substrate-precursor complex becomes stronger, the sidebands in the IR spectrum should move away from the monomer bands and Mulliken charge-transfer bands should appear in the UV/vis spectrum. In the limit of strong complex formation, the electronic structure of the complex becomes quite distinct from that of substrate or precursor (type c, Scheme IV). Atom transfer may now be achieved by photolysis in a region where neither substrate nor precursor absorbs. Aside from the example of NO·O₃ cited the most striking examples come from complexes of metals. It was apparently not recognized by the investigators^{57,58} of MO_x (x = 1, 2; M = Cu, Ag, Au) that the sensitivity of O₂/M/Ar deposits to near UV light arose most likely from the formation of dioxygen complexes.^{55,181} In some of these experiments there remains the possibility of metal-atom excitation. However, the observation of fluorescence of CuO₂ on laser irradiation at 483 nm⁵⁶ almost certainly depended on photolysis of Cu(η¹-O₂)⁵⁵ (see sections IIB and VB2). The photooxidation of M(CO)₆ (M = Cr, Mo, W) by O₂, CO₂, and N₂O depends on initial photolysis of the hexacarbonyl precursor to form a complex with the substrate and subsequent photolysis of that complex. For instance, the complex OCO...Cr(CO)₅ has

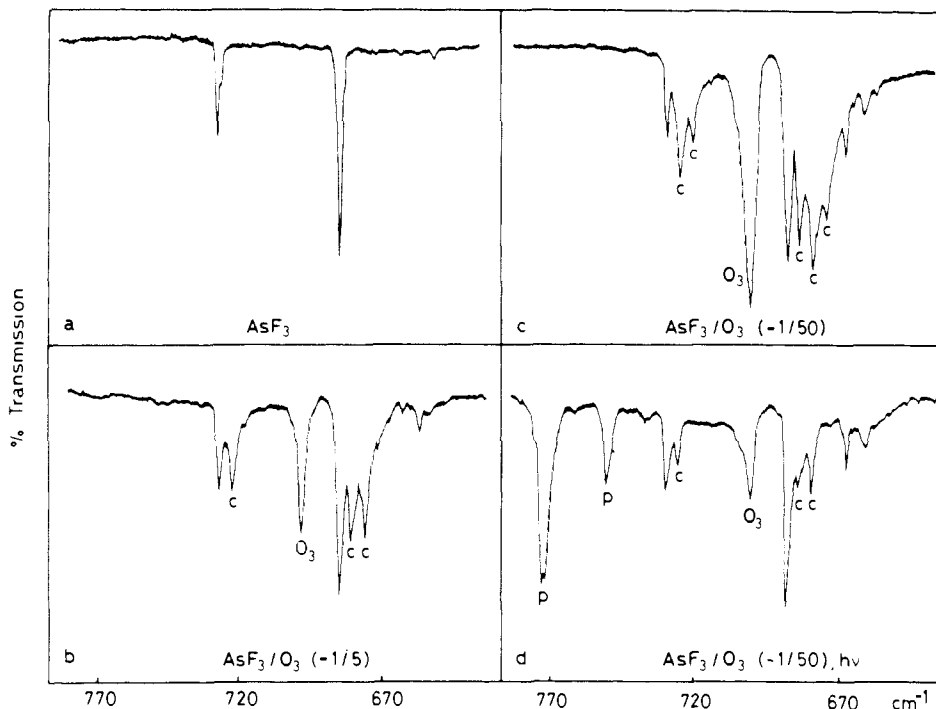

Figure 13. IR spectra of (a) AsF_3/Kr (estimated ratio $\sim 1/5000$), (b) $\text{AsF}_3/\text{O}_3/\text{Kr}$ ($\sim 1/5/5000$), (c) $\text{AsF}_3/\text{O}_3/\text{Kr}$ ($\sim 1/50/5000$), (d) sample c after 30-min mercury arc photolysis. Note growth of bands assigned to $\text{AsF}_3\cdot\text{O}_3$ complex (marked C) with increasing O_3 concentration and decay of these bands during photolysis. P, OAsF_3 ; C, $\text{AsF}_3\cdot\text{O}_3$; other bands due to AsF_3 and O_3 . Adapted with permission from ref 161b.

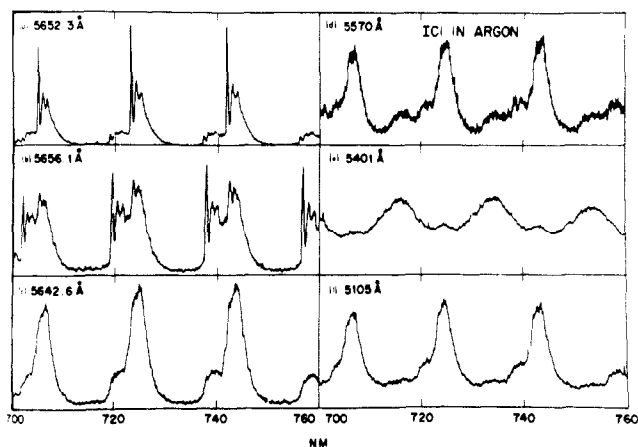

Figure 14. Emission spectra of ICl in Ar from the $v = 0$ BO^+ state as a function of excitation wavelength. In (c) and (a) weak bands to left of principal bands are due to I^{37}Cl . In (b) I^{37}Cl component is enhanced by resonant excitation on $v = 3$ threshold. Note absence of zero phonon lines when excitation wavelength less than 565.6 nm. Reproduced with permission from ref 179. Copyright 1975, American Institute of Physics.

IR and UV spectra comparable to the better established $\text{H}_3\text{CCN}-\text{Cr}(\text{CO})_5$ and quite distinct from $\text{Ar}\cdots\text{Cr}(\text{CO})_5$. Selective photolysis of the CO_2 complex yields oxo metal products.⁹⁰ A recent non-metal example shows the formation of $\text{ICl}\cdot\text{O}_3$ with a distinct charge-transfer absorption at 460 nm; photolysis yields OICl .¹⁵⁷

A corollary to complex formation prior to photochemical reaction, is the formation of products as complexes. For instance photolysis of $\text{H}_2\text{O}/\text{F}_2/\text{N}_2$ matrices yields the $\text{HOF}\cdot\text{HF}$ complex.¹⁶⁴ The perturbation of such a strongly hydrogen-bonded complex is appreciable: compare the fundamentals of complexed HOF (3493, 1394, 885 cm^{-1}) and isolated HOF in N_2 matrices (3537, 1359, 886 cm^{-1}). Such perturbations must be common in atom-transfer reactions.

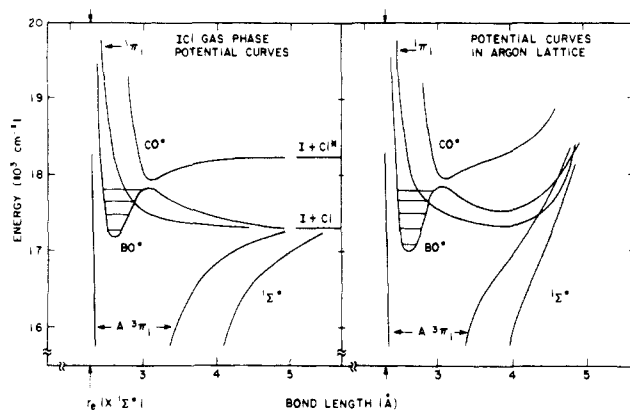

Figure 15. Estimated potential energy curves of ICl in gas phase (left) and argon matrix (right). Note minor perturbation of bound levels, but major effect of cage potential (impulsive limit) at high internuclear distances. Reproduced with permission from ref 179. Copyright 1975, American Institute of Physics.

(4) **The Cage Effect.** An attempted photochemical atom transfer may fail or be limited by lack of diffusion or lack of formation of a suitable complex, but the commonest reason for failure is in-cage recombination of the precursor. The cage effect in matrices has been thoroughly documented by Bondybey and others who have studied the photophysics of ICl ,¹⁷⁹ CF_3I , CH_3I ,¹⁸⁰ Br_2 ,¹⁸² S_2 ,¹⁴² Cu_2 ,^{166,183,184} and Ag_2 ¹⁸⁵ in matrices. As indicated above, in-cage recombination is essentially 100% effective for the non-metal compounds, but significant dissociation occurs for Cu_2 and Ag_2 .

Bondybey and Brus studied the vibrationally relaxed BO^+ fluorescence following laser excitation above and below the gas-phase dissociation barrier of ICl. Even 0.8 eV above the BO^+ gas-phase dissociation energy, emission was observed with a risetime < 10 ns and the quantum yield for permanent dissociation was $< 5 \times$

10^{-4} . When excited below the dissociation barrier the emission is structured but this structure disappears at higher energies (Figure 14). The effect of the matrix on the potential energy curve is extremely slight in the bound region but the cage effect imposes an extra well at larger internuclear distances (Figure 15). By using the photoselection technique and polarized light it was shown that the molecule recombines in essentially the same orientation *regardless* of excitation wavelength. These observations indicate rapid propagation of energy away from the site of light absorption and that there is no local hot spot. The Cl atom collides with essentially one host atom in an impulsive collision with efficient kinetic energy transfer, since the motions of the lattice are at much lower frequency. In contrast, the matrix exerts only a minor van der Waals cage potential for host atom movement in the adiabatic limit of slow expansion.

In a very weakly bound molecule such as Ca_2 , the effect of the matrix potential is to cause a slight increase in ω_e'' and a uniform decrease in anharmonicity, so increasing the well depth but retaining an almost perfect Morse potential.¹⁶⁶ This again emphasizes the freedom of the molecule to rearrange in the *adiabatic* limit.

(5) Role of Electronically Excited Atoms. Several of the photochemical sources of O, N, and S atoms produce electronically excited atoms. The sources and wavelengths required for generating excited atoms have been discussed earlier, but it is often a matter of conjecture whether excited- or ground-state atoms are involved in the atom-transfer reactions. However, three types of experiment have yielded clear information. In the first the source of atoms or the excitation wavelengths for generating atoms is varied. Thus, generation of HSOH^{156} and SO_4^6 by ozone photolysis in the 500–600-nm region clearly indicates involvement of ground state O atoms. However, one should be wary of the converse experiment in which it is claimed that short-wavelength irradiation is required since the excitation coefficient of ozone is 3000 times greater in the UV than in the visible.¹⁰⁰ The second type of experiment involves observation of thermoluminescence which must take place with relaxed atoms in their ground states (examples may be found in section IVD2, the relaxation times are discussed in section IVC). In the third type of experiment emission is observed from a state of the product molecule correlating with an excited atom, as in the ArO experiments.^{83,85} These experiments represent the best proof of the involvement of *excited* atoms in matrix reactions.

Less satisfactory than experiment is reliance on theoretical correlations or gas-phase results. In this context a warning is served by Pimentel's observation of a thermal reaction in a matrix between NO and O_3 which has not been detected in the gas phase.¹⁵⁴ However, we may be fairly certain that reaction of O atoms with N_2 in a matrix to form N_2O does involve $\text{O}(^1\text{D})$.

It was suggested above that formation of substrate-precursor complexes may be required for reaction of some excited-state atoms because of their short lifetime. Unfortunately, so few lifetimes are known that this is very speculative. The relaxation times of $\text{N}(^2\text{D})$ and $\text{O}(^1\text{D})$ are long enough ($1\text{--}10^2$ s) to allow diffusion out

of the cage prior to relaxation.^{119,88} The relaxation time of $\text{O}(^1\text{S})$ in Ar (560 ms)⁸⁸ suggests that this may also be true for $\text{O}(^1\text{S})$ and $\text{S}(^1\text{S})$. However, the variation of a factor of 50 in relaxation time of $\text{N}(^2\text{D})$ on changing from Kr to Ne^{119} indicates that atom-transfer reactions involving excited states should be sensitive to the matrix employed. There are also indications that lifetimes may be strongly dependent on dopant concentration. In addition to these non-metal atoms, it has been argued that $\text{Cu}(^2\text{D})$ lives long enough to diffuse appreciably.⁶⁶

It is normally assumed that the matrix is not directly involved in the photoprocesses. However, at sufficiently high energies matrix excitons may be excited (thresholds are approximately 12 eV in Ar, 10 eV in Kr, and 8 eV in Xe).¹⁸⁷ Taylor et al.⁸³ have shown that the excitation spectrum for production of $\text{O}(^1\text{S})$ from CO_2 in Ar corresponds to direct excitation of CO_2 in the 10–12-eV range. However, a quite different excitation spectrum is found in CO_2 -doped Kr. This time the $\text{O}(^1\text{S})$ is formed via the Kr excitons at 10.2 and 10.8 eV. There is a similar contrast between the excitation spectra for Kr/ N_2O which is dominated by molecular absorption and that for Xe/ N_2O which shows prominent exciton features.⁸⁴ The excitation spectra of Ar/ N_2O and of Kr/OCS matrices (see Figure 7a) show both molecular and exciton absorption features.⁸⁵ No $\text{O}(^1\text{S})$ could be generated from O_2/Ar matrices, but the excited atom was observed in O_2/Kr matrices, implying that indirect excitation may be essential in this example.⁸³ Following absorption by matrix excitons the energy must be transferred to the dopant. There is evidence both for resonant energy transfer and nonresonant transfer. The nonresonant transfer is thought to involve charge transfer from Kr to dopant followed by dissociation, e.g.:

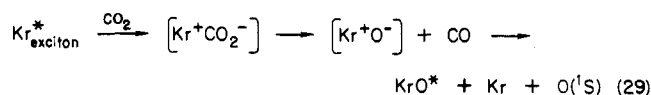

The nature of rare-gas matrix excitons and their role in the formation of ions is discussed more fully in section VC of the following review.²⁵

(6) Outstanding Problems in the Mechanisms of Atom-Transfer Reactions. Although photochemical atom transfer has been widely used in matrix synthesis, much more effort is needed in mechanistic studies of these reactions. Of particular importance are measurements of (i) excitation spectra for atom production and (ii) relaxation times of excited atoms, since these measurements lay the foundation for mechanistic studies. In individual mechanistic studies it is important to investigate (i) whether a complex is formed between precursor and substrate and whether the complex alone is photosensitive, (ii) the effect of changing the source of the atoms, (iii) the effect of changing the irradiation wavelength for production of atoms, (iv) the effect of changing the matrix, and (v) the photosensitivity of the products, since this will affect the conclusions drawn from (ii) and (iii).

Acknowledgments. I should like to express my thanks to Dr. M. Hawkins and Dr. A. J. Downs for communicating results prior to publication. Both of them and Dr. R. F. Barrow and Prof. R. J. Donovan

have made helpful comments on this review.

References

- (1) See, for example, Clark, R. J. H.; Cobbold, D. G. *Inorg. Chem.* 1978, 17, 3169.
- (2) Whittle, E.; Dows, D. A.; Pimentel, G. C. *J. Chem. Phys.* 1954, 22, 1943.
- (3) (a) Ozin, G. A.; Mitchell, S. A. *Angew. Chem., Int. Ed. Engl.* 1983, 22, 674; (b) Barnes, A. J., Orville-Thomas, W. J., Müller, A., Gaufrès, R., Eds. "Matrix Isolation Spectroscopy"; Reidel: London, 1980.
- (4) Orth, R. G.; Jonkman, H. T.; Powell, D. H.; Michl, J. *J. Am. Chem. Soc.* 1981, 103, 6026. Kohl, J. E.; Semack, M. G.; White, D. J. *J. Chem. Phys.* 1978, 69, 5378. Zilm, K. W.; Grant, D. M. *J. Am. Chem. Soc.* 1981, 103, 2913.
- (5) Varetti, E. L.; Pimentel, G. C. *J. Chem. Phys.* 1971, 55, 3813.
- (6) Kugel, R.; Taube, H. *J. Phys. Chem.* 1975, 79, 2130.
- (7) Ozin, G. A.; McCaffrey, J. A. *J. Am. Chem. Soc.* 1982, 104, 7351.
- (8) Billups, W. E.; Konarski, M. M.; Hauge, R. H.; Margrave, J. L. *J. Am. Chem. Soc.* 1980, 102, 7393.
- (9) Ault, B. S.; Andrews, L. *J. Chem. Phys.* 1976, 65, 4192.
- (10) Turner, J. J.; Pimentel, G. C. *Science* 1963, 140, 974.
- (11) Perutz, R. N.; Turner, J. J. *J. Am. Chem. Soc.* 1975, 97, 4791.
- (12) Barnes, A. J., in ref 16.
- (13) Jacox, M. E. *J. Phys. Chem. Ref. Data*, in press.
- (14) Grinter, R.; Stern, D. R. *J. Chem. Soc., Faraday Trans. 2* 1983, 79, 1011; Breithaupt, B.; Hulse, J. E.; Kolb, D. M.; Rotermund, H. H.; Schroeder, W.; Schrittenlacher, W. *Chem. Phys. Lett.* 1983, 95, 513.
- (15) Gedanken, A.; Raz, B.; Jortner, J. *J. Chem. Phys.* 1973, 58, 1178.
- (16) Hallam, H. E., Ed. "Vibrational Spectroscopy of Trapped Species"; Wiley: London, 1973.
- (17) Meyer, B. "Low-Temperature Spectroscopy"; Elsevier: Amsterdam, 1971.
- (18) Moskovits, M.; Ozin, G. A., Ed. "Cryochemistry"; Wiley: New York, 1976.
- (19) Klein, M. L.; Venables, J. A., Ed. "Rare Gas Solids"; Academic Press: London, 1977; Vol. I, II.
- (20) Cradock, S.; Hinchliffe, A. J. "Matrix Isolation"; Cambridge University Press: London, 1975.
- (21) Milligan, D. E.; Jacox, M. E. In "Molecular Spectroscopy, Modern Research"; Rao, K. N.; Matthews, C. W., Eds.; Academic Press: New York, 1972.
- (22) Jacox, M. E. In "Reviews of Chemical Intermediates"; Strausz, O. P., Ed.; Verlag Chemie: Weinheim, West Germany, 1978; Vol. 2, p 1.
- (23) Andrews, L. *Annu. Rev. Phys. Chem.* 1979, 30, 79.
- (24) Downs, A. J.; Peake, S. C. *Mol. Spectrosc. (Chem. Soc., London)* 1973, 1, 523. Chadwick, B. M. *Ibid.* 1975, 3, 281; 1979, 6, 72.
- (25) Perutz, R. N. *Chem. Rev.*, following paper in this issue.
- (26) Howard, W. F., Jr.; Andrews, L. *Inorg. Chem.* 1975, 14, 409.
- (27) Kasai, P. H. *Phys. Rev. Lett.* 1968, 21, 67.
- (28) Kasai, P. H.; McLeod, D., Jr. *J. Chem. Phys.* 1969, 51, 1250. Kasai, P. H. *Acc. Chem. Res.* 1971, 4, 329.
- (29) Marti, V. P. J.; Roberts, B. P. *J. Chem. Soc., Chem. Commun.* 1984, 272.
- (30) Milligan, D. E.; Jacox, M. E. *J. Chem. Phys.* 1969, 51, 1952.
- (31) Milligan, D. E.; Jacox, M. E. *J. Chem. Phys.* 1970, 53, 2034.
- (32) Milligan, D. E.; Jacox, M. E. *J. Chem. Phys.* 1971, 55, 2550.
- (33) Ault, B. S.; Andrews, L. *J. Chem. Phys.* 1976, 64, 4853. Ault, B. S. *Acc. Chem. Res.* 1982, 15, 103.
- (34) Kasai, P. H.; McLeod, D., Jr. *J. Am. Chem. Soc.* 1974, 96, 2342. Kasai, P. H. *J. Phys. Chem.* 1982, 86, 4092.
- (35) Milligan, D. E.; Jacox, M. E. *J. Chem. Phys.* 1971, 55, 3405. Jacox, M. E.; Milligan, D. E. *J. Mol. Spectrosc.* 1972, 43, 148.
- (36) See, for example: Wolf, J.; Werner, H.; Serhadli, O.; Ziegler, M. L. *Angew. Chem., Int. Ed. Engl.* 1983, 22, 414.
- (37) Barefield, J. E.; Guillory, W. A. *J. Phys. Chem.* 1977, 81, 634.
- (38) Breeze, P. A.; Burdett, J. K.; Turner, J. J. *Inorg. Chem.* 1981, 20, 3369.
- (39) Power, W. J.; Ozin, G. A. *Adv. Inorg. Chem. Radiochem.* 1980, 23, 79.
- (40) Poliakov, M.; Turner, J. J. *J. Chem. Soc., Faraday Trans. 2* 1974, 70, 93.
- (41) Peden, C. H. F.; Parker, S. F.; Barrett, P. H.; Pearson, R. G. *J. Phys. Chem.* 1983, 87, 2329.
- (42) Parker, S. F.; Peden, C. H. F.; Barrett, P. H.; Pearson, R. G. *Inorg. Chem.* 1983, 22, 2813.
- (43) Foonsnaes, T.; Pellen, M. J.; Gruen, D. M. *J. Chem. Phys.* 1983, 78, 2889.
- (44) Perutz, R. N.; Turner, J. J. *J. Am. Chem. Soc.* 1975, 97, 4800.
- (45) Elian, M.; Hoffmann R. *Inorg. Chem.* 1975, 14, 1058. Burdett, J. K. *Ibid.* 1975, 14, 375.
- (46) Ozin, G. A.; McIntosh, D. F.; Mitchell, S. A. *J. Am. Chem. Soc.* 1981, 103, 1574.
- (47) Ozin, G. A.; Mitchell, S. A.; Garcia-Prieto, J. *Angew. Chem., Int. Ed. Engl.* 1982, 21, 381.
- (48) Ozin, G. A.; McCaffrey, J. G.; McIntosh, D. F. *Pure Appl. Chem.* 1984, 56, 111. Ozin, G. A.; McCaffrey, J. G. *J. Am. Chem. Soc.* 1984, 106, 807.
- (49) Ozin, G. A.; Mitchell, S. A.; Garcia-Prieto, J. *Angew. Chem., Int. Ed. Engl.* 1982, 21, 211. Kaffi, Z. H.; Hauge, R. H.; Fredin, L.; Billups, W. E.; Margrave, J. L. *J. Chem. Soc., Chem. Commun.* 1983, 1230.
- (50) Ozin, G. A.; Mitchell, S. A.; Garcia-Prieto, J. *Angew. Chem., Int. Ed. Engl.* 1982, 21, 380.
- (51) Chetwynd-Talbot, J.; Grebenik, P.; Perutz, R. N. *Inorg. Chem.* 1982, 21, 3647.
- (52) Berry, M.; Elmitt, K.; Green, M. L. H. *J. Chem. Soc., Dalton Trans.* 1979, 1950.
- (53) Hoyano, J. K.; McMaster, A. D.; Graham, W. A. G. *J. Am. Chem. Soc.* 1983, 105, 7190.
- (54) Strausz, O. P.; Gunning, H. E. *Adv. Photochem.* 1966, 4, 143.
- (55) Ozin, G. A.; Mitchell, S. A.; Garcia-Prieto, J. *J. Am. Chem. Soc.* 1983, 105, 6399.
- (56) Tevault, D. E. *J. Chem. Phys.* 1982, 76, 2859. Bondybey, V. E.; English, J. H. *J. Phys. Chem.* 1984, 88, 2247.
- (57) Thompson, K. R.; Easley, W. C.; Knight, L. B. *J. Phys. Chem.* 1973, 77, 49.
- (58) Griffiths, M. J.; Barrow, R. F. *J. Chem. Soc., Faraday Trans. 2* 1977, 73, 943.
- (59) Baumann, C. A.; Van Zee, R. J.; Weltner, W. *J. Phys. Chem.* 1982, 86, 5084.
- (60) De Vore, T. C.; Van Zee, R. J.; Weltner, W. *J. Chem. Phys.* 1978, 68, 3522.
- (61) Hauge, R. H.; Kauffman, J. W.; Margrave, J. L. *J. Am. Chem. Soc.* 1980, 102, 6005. Douglas, M. A.; Hauge, R. H.; Margrave, J. L. *J. Chem. Soc., Faraday Trans. 1* 1983, 79, 1533.
- (62) Ismail, Z. K.; Hauge, R. H.; Fredin, L.; Kauffmann, J. W.; Margrave, J. L. *J. Chem. Phys.* 1982, 77, 1617.
- (63) Vreede, H. J.; Claridge, R. G. C.; Phillips, L. F. *Chem. Phys. Lett.* 1974, 27, 1.
- (64) Ozin, G. A.; Huber, H. *Inorg. Chem.* 1978, 17, 155.
- (65) Klotzbücher, W. E.; Ozin, G. A. *J. Am. Chem. Soc.* 1978, 100, 2262; *Inorg. Chem.* 1979, 18, 2101. Pellin, M. J.; Foonsnaes, T.; Gruen, D. M. *J. Chem. Phys.* 1981, 74, 5547. Pellin, M. J.; Gruen, D. M. *Ibid.* 1983, 79, 5587.
- (66) Ozin, G. A.; Huber, H.; McIntosh, D.; Mitchell, S.; Norman, J. G.; Noodleman, L. *J. Am. Chem. Soc.* 1979, 101, 3504. Ozin, G. A.; Mitchell, S. A.; McIntosh, D. F.; Mattar, S. M.; Garcia-Prieto, J. *J. Phys. Chem.* 1983, 87, 4651. Ozin, G. A.; Mitchell, S. A.; Garcia-Prieto, J. *Ibid.* 1982, 86, 473.
- (67) Ozin, G. A.; Hanlan, A. J. L. *Inorg. Chem.* 1979, 18, 1781.
- (68) Ozin, G. A.; Huber, H. *Inorg. Chem.* 1979, 18, 1402.
- (69) Ozin, G. A.; Klotzbücher, W. E. *Inorg. Chem.* 1979, 18, 2101.
- (70) Mitchell, S. A.; Farrell, J.; Kenney-Wallace, G. A.; Ozin, G. A. *J. Am. Chem. Soc.* 1980, 102, 7702. Mitchell, S. A.; Ozin, G. A. *J. Phys. Chem.* 1984, 88, 1425.
- (71) *Photochemistry 1970-1982*, 1-13.
- (72) Donovan, R. J.; Husain, D. *Chem. Rev.* 1970, 70, 489.
- (73) Donovan, R. J.; Gillespie, H. M. *React. Kinet.* 1975, 1, 14. Clynne, M. A. A.; Curran, H. H. *Gas Kinetic Energy Transfer 1977*, 2, 239. Baggott, J. E.; Pilling, M. J. *Annu. Rep.—R. Soc. Chem., Sect. C* 1982, 79, 199.
- (74) Strausz, O. P.; Gunning, H. E. *Adv. Photochem.* 1966, 4, 143.
- (75) Huie, R. E.; Herron, J. T. *Prog. React. Kinet.* 1978, 8, 1.
- (76) Milligan, D. E.; Jacox, M. E. *J. Chem. Phys.* 1964, 41, 3032. Wakahara, A.; Miyazaki, T.; Fueki, K. *J. Phys. Chem.* 1982, 86, 1781. Bhattacharya, D.; Wang, H. Y.; Willard, J. E. *Ibid.* 1981, 85, 1310. Fenrick, H. F.; Bhattacharya, D.; Willard, J. E. *Ibid.* 1981, 85, 1324.
- (77) (a) Milligan, D. E.; Jacox, M. E. *J. Chem. Phys.* 1969, 51, 277; 1967, 47, 5146. (b) Van Ijendoorn, L. J.; Allamandola, L. F.; Baas, F.; Greenberg, J. M. *Ibid.* 1983, 78, 7019.
- (78) Milligan, D. E.; Jacox, M. E. *J. Chem. Phys.* 1965, 43, 4487.
- (79) Jacox, M. E.; Milligan, D. E.; Moll, N. G.; Thompson, W. E. *J. Chem. Phys.* 1965, 43, 3734. Krogh, D. O.; Ward, C. H.; Hollenbeck, J. M.; *J. Phys. Chem.* 1982, 86, 2892.
- (80) Milligan, D. E.; Jacox, M. E. *J. Chem. Phys.* 1967, 47, 5157.
- (81) Brom, J. M., Jr.; Broida, H. P. *Chem. Phys. Lett.* 1975, 33, 384.
- (82) Jones, P. R.; Taube, H. *J. Phys. Chem.* 1973, 77, 1007.
- (83) Taylor, R. V.; Scott, W.; Findley, P. R.; Wu, Z.; Walker, W. C. *J. Chem. Phys.* 1981, 74, 3718.
- (84) Monahan, K. M.; Rehn, V. *J. Chem. Phys.* 1978, 68, 3814.
- (85) Taylor, R. V.; Walker, W. C.; Monahan, K. M.; Rehn, V. *J. Chem. Phys.* 1980, 72, 6743.
- (86) Goodman, J.; Tully, J. C.; Bondybey, V. E.; Brus, L. E. *J. Chem. Phys.* 1977, 66, 4802.

- (87) Taylor, R. V.; Walker, W. C. *J. Chem. Phys.* 1979, 70, 284.
- (88) Fournier, J.; Mohammed, H. H.; Deson, J.; Maillard, D. *Chem. Phys.* 1982, 70, 39.
- (89) Hawkins, M.; Downs, A. J. *J. Phys. Chem.* 1984, 88, 1527.
- (90) Poliakoff, M.; Smith, K. P.; Turner, J. J.; Wilkinson, A. J. *J. Chem. Soc., Dalton Trans.* 1982, 651. Crayston, J. A.; Almond, M. J.; Downs, A. J.; Poliakoff, M.; Turner, J. J. *Inorg. Chem.* 1984, 22, 3051. Almond, M. J.; Downs, A. J.; Perutz, R. N. *Inorg. Chem.*, in press.
- (91) Spratley, R. D.; Turner, J. J.; Pimentel, G. C. *J. Chem. Phys.* 1966, 44, 2063.
- (92) Milligan, D. E.; Jacox, M. E.; Bass, A. M.; Comeford, J. J.; Mann, D. E. *J. Chem. Phys.* 1965, 42, 3187.
- (93) Milligan, D. E.; Jacox, M. E. *J. Chem. Phys.* 1970, 52, 2594.
- (94) Larzillière, M.; Jacox, M. E. *J. Mol. Spectrosc.* 1980, 79, 132.
- (95) Smardzewski, R. R. *J. Chem. Phys.* 1978, 68, 2878.
- (96) Long, S. R.; Pimentel, G. C. *J. Chem. Phys.* 1977, 66, 2219.
- (97) Fournier, J.; Lalo, C.; Deson, J.; Vermeil, J. *J. Chem. Phys.* 1977, 66, 2656.
- (98) Bondybey, V. E.; English, J. H.; Miller, T. A. *J. Chem. Phys.* 1979, 70, 1621.
- (99) Jacox, M. E.; Milligan, D. E. *J. Chem. Phys.* 1965, 43, 866.
- (100) Inn, E. C. Y.; Tanaka, Y. *J. Opt. Soc. Am.* 1953, 43, 870.
- (101) De More, W. B.; Raper, O. F. *J. Chem. Phys.* 1962, 37, 2048.
- (102) Lin, C.-L.; De More, W. B. *J. Photochem.* 1973, 2, 161.
- (103) Moortgat, G. K.; Kudzusz, E.; Warneck, P. *J. Chem. Soc., Faraday Trans. 2* 1977, 73, 1216.
- (104) Rabalais, J. W.; McDonald, J. M.; Scherr, V.; McGlynn, S. P. *Chem. Rev.* 1971, 71, 73.
- (105) Preston, K. F.; Barr, R. F. *J. Chem. Phys.* 1971, 54, 3347.
- (106) Black, G.; Sharpless, R. L.; Slanger, T. G.; Lorents, D. C. *J. Chem. Phys.* 1975, 62, 4266.
- (107) Sidhu, K. S.; Csizmadia, I. G.; Strausz, O. P.; Gunning, H. E. *J. Am. Chem. Soc.* 1966, 88, 2412.
- (108) McNesby, J. R.; Okabe, H. *Adv. Photochem.* 1964, 3, 157.
- (109) Graham, W. R. M.; Dismuke, K. I.; Weltner, W., Jr. *J. Chem. Phys.* 1974, 60, 3817.
- (110) Foner, S. N.; Cochran, E. L.; Bowers, V. A.; Jen, C. K. *J. Chem. Phys.* 1960, 32, 963.
- (111) Morton, J. R.; Preston, K. F.; Strach, S. J.; Adrian, F. J.; Nette, A. N. *J. Chem. Phys.* 1979, 70, 2889.
- (112) Kinugawa, K.; Miyazaki, T.; Hase, H. *J. Phys. Chem.* 1978, 82, 1697.
- (113) Boate, A. R.; Morton, J. R.; Preston, K. F. *Chem. Phys. Lett.* 1978, 54, 579. Adrian, F. J.; Bowers, V. A. *J. Chem. Phys.* 1976, 65, 4316.
- (114) Morehouse, R. L.; Christiansen, J. J.; Gordy, W. *J. Chem. Phys.* 1966, 45, 1747.
- (115) Muto, H.; Nunome, K.; Iwasaka, M. *J. Phys. Chem.* 1980, 84, 3403.
- (116) (a) Brom, J. M.; Lepak, E. *J. Chem. Phys. Lett.* 1976, 41, 185. (b) Cook, G.; Krogh, O. D. *J. Chem. Phys.* 1981, 74, 841.
- (117) Brom, J. M., Jr.; Broida, H. P. *Chem. Phys. Lett.* 1975, 33, 384.
- (118) Fournier, J.; Deson, J.; Vermeil, C.; Pimentel, G. C. *J. Chem. Phys.* 1979, 70, 5726.
- (119) Bondybey, V. E.; English, J. H. *J. Phys. Chem.* 1983, 87, 4647.
- (120) Tinti, D. S.; Robinson, G. W. *J. Chem. Phys.* 1968, 49, 3229. A summary of early X irradiation experiments may be found in: Gruen, D. M., ref 18.
- (121) Hörl, E. M. *J. Mol. Spectrosc.* 1959, 3, 425.
- (122) Adrian, F. J.; Cochran, E. L.; Bowers, V. A. *J. Chem. Phys.* 1967, 47, 5441; 1962, 36, 1661. Rakoczi, F. J.; Ha, T. K.; Günthard, H. H. *Chem. Phys.* 1983, 74, 273. Bhattacharya, D.; Willard, J. E. *J. Phys. Chem.* 1982, 86, 962.
- (123) Adrian, F. J.; Cochran, E. L.; Bowers, V. A. *J. Chem. Phys.* 1972, 56, 6251.
- (124) Milligan, D. E.; Jacox, M. E. *J. Chem. Phys.* 1964, 42, 3032; 1969, 51, 277.
- (125) Jacox, M. E. *Chem. Phys. Lett.* 1978, 56, 43; *J. Mol. Spectrosc.* 1973, 47, 1418.
- (126) Jacox, M. E.; Milligan, D. E.; Moll, N. G.; Thompson, W. E. *J. Chem. Phys.* 1965, 43, 3734.
- (127) Milligan, D. E.; Jacox, M. E. *J. Chem. Phys.* 1967, 47, 5157.
- (128) Jacox, M. E. *J. Mol. Spectrosc.* 1980, 80, 257.
- (129) Jacox, M. E.; Milligan, D. E. *J. Chem. Phys.* 1965, 43, 866.
- (130) Moll, N. G.; Thompson, W. E. *J. Chem. Phys.* 1966, 44, 2684.
- (131) Jacox, M. E. *J. Mol. Spectrosc.* 1978, 72, 26.
- (132) Walker, N.; Tevault, D. E.; Smardzewski, R. R. *J. Chem. Phys.* 1978, 69, 564.
- (133) Ault, B. S.; Andrews, L.; Green, D. W.; Reedy, G. T. *J. Chem. Phys.* 1977, 66, 2786. Howard, W. F., Jr.; Andrews, L. *J. Am. Chem. Soc.* 1974, 96, 7864.
- (134) Hastie, J. W.; Hauge, R.; Margrave, J. L. *J. Inorg. Nucl. Chem.* 1969, 31, 281.
- (135) Jacox, M. E.; Milligan, D. E. *J. Mol. Spectrosc.* 1972, 42, 495.
- (136) Lorents, D. C.; Huestis, D. L.; McCusker, M. V.; Nakano, N. H.; Hill, R. M. *J. Chem. Phys.* 1978, 68, 4657.
- (137) Downs, A. J.; Hawkins, M., private communication.
- (138) Weissberger, E.; Breckenridge, W. H.; Taube, H. *J. Chem. Phys.* 1967, 47, 1764.
- (139) Lin, C. L.; De More, W. B. *J. Phys. Chem.* 1973, 77, 863.
- (140) Chetwynd-Talbot, J.; Grebenik, P.; Perutz, R. N.; Powell, M. H. A. *Inorg. Chem.* 1983, 22, 1675.
- (141) Lee, Y. P.; Pimentel, G. C. *J. Chem. Phys.* 1981, 74, 4851.
- (142) Bondybey, V. E.; English, J. H. *J. Chem. Phys.* 1978, 69, 1865; 1980, 72, 3113.
- (143) Ault, B. S.; Andrews, L. *J. Chem. Phys.* 1976, 65, 4192.
- (144) Goodman, J.; Brus, L. E. *J. Chem. Phys.* 1976, 65, 3808.
- (145) Adrian, F. J.; Bowers, V. A.; *J. Chem. Phys.* 1976, 65, 4316.
- (146) Goetschalckx, M. A.; Mowery, R. L.; Krausz, E. R.; Yeakel, W. C.; Schatz, P. N.; Ault, B. S.; Andrews, L. *Chem. Phys. Lett.* 1977, 47, 23.
- (147) Ault, B. S.; Andrews, L. *Chem. Phys. Lett.* 1976, 43, 350.
- (148) Taylor, R. V.; Walker, W. C. *Appl. Phys. Lett.* 1979, 35, 359.
- (149) Jacox, M. E.; Milligan, D. E. *J. Mol. Spectrosc.* 1973, 48, 536.
- (150) Kasai, P. H. *J. Am. Chem. Soc.* 1972, 94, 5950.
- (151) Johnson, G. L.; Andrew, L. *J. Am. Chem. Soc.* 1980, 102, 5736.
- (152) Toriyama, K.; Nunome, K.; Iwasaki, M. *J. Phys. Chem.* 1980, 84, 2374. Wakahara, A.; Miyuzaki, T.; Fueki, K. *Ibid.* 1982, 86, 1781.
- (153) Fournier, J.; Deson, J.; Vermeil, C. *J. Chem. Phys.* 1977, 67, 5688.
- (154) Frei, H.; Pimentel, G. C. *J. Phys. Chem.* 1981, 85, 3355. Lucas, D.; Pimentel, G. C. *J. Phys. Chem.* 1979, 83, 2311.
- (155) Schwager, I.; Arkell, A. *J. Am. Chem. Soc.* 1967, 89, 6006.
- (156) Smardzewski, R. R.; Lin, M. C. *J. Chem. Phys.* 1977, 66, 3197. Shirik, A. E.; Shirik, J. S. *J. Mol. Spectrosc.* 1982, 92, 218.
- (157) Andrews, L.; Chi, F. K.; Arkell, A. *J. Am. Chem. Soc.* 1974, 96, 1997. Bhatia, S. C.; Hall, J. W. *Inorg. Chem.* 1981, 20, 629. Hawkins, M.; Andrews, L.; Downs, A. J.; Drury, D. J. *J. Am. Chem. Soc.* 1984, 106, 3076.
- (158) Tevault, D. E.; Mowery, R. L.; De Marco, R. A.; Smardzewski, R. R. *J. Chem. Phys.* 1981, 74, 4342. Butler, R.; Katz, S.; Snelson, A.; Stephens, J. B. *J. Phys. Chem.* 1979, 83, 2578.
- (159) Chi, F. K.; Andrews, L. *J. Phys. Chem.* 1973, 77, 3062.
- (160) Benfield, F. W. S.; Downs, A. J.; Gaskill, G. P.; Staniforth, S. E. *J. Chem. Soc., Chem. Commun.* 1976, 856.
- (161) (a) Downs, A. J.; Gaskill, G. P.; Saville, S. B. *Inorg. Chem.* 1982, 21, 3385. (b) Gaskill, G. P. Ph.D. Thesis, University of Oxford, 1978.
- (162) Haller, I.; Pimentel, G. C. *J. Am. Chem. Soc.* 1962, 84, 2855. Hawkins, M.; Andrews, L. *J. Am. Chem. Soc.* 1983, 105, 2523.
- (163) Sodeau, J. R.; Lee, E. K. C. *J. Phys. Chem.* 1980, 84, 3359.
- (164) Noble, P. N.; Pimentel, G. C. *Spectrochim. Acta, Part A* 1969, 24A, 797. Goleb, J. A.; Claassen, H. H.; Studier, M. H.; Appelman, E. H. *Ibid.* 1972, 28A, 65.
- (165) Arkell, A. *J. Phys. Chem.* 1969, 73, 3877.
- (166) Smardzewski, R. R.; Fox, W. B. *J. Chem. Phys.* 1974, 60, 2980.
- (167) Smardzewski, R. R.; Fox, W. B. *J. Chem. Phys.* 1974, 60, 2104.
- (168) (a) Schnoeckel, H. *J. Mol. Struct.* 1981, 70, 183. (b) Prochaska, E. S.; Andrews, L. *Inorg. Chem.* 1977, 16, 339.
- (169) Prochaska, E. S.; Andrews, L.; Smyrl, N. R.; Mamantov, G. *Inorg. Chem.* 1978, 17, 970.
- (170) Milligan, D. E.; Jacox, M. E. *J. Chem. Phys.* 1968, 48, 4811.
- (171) Milligan, D. E.; Jacox, M. E. *J. Chem. Phys.* 1968, 48, 2265; 1966, 44, 4058.
- (172) Jacox, M. E.; Milligan, D. E. *J. Chem. Phys.* 1967, 46, 184.
- (173) Jacox, M. E. *Chem. Phys.* 1979, 42, 133; 1981, 59, 199; 1981, 59, 213; 1982, 69, 407; *J. Phys. Chem.* 1983, 87, 4940.
- (174) Wight, C. A.; Willner, H.; Andrews, L. *J. Mol. Spectrosc.* 1978, 72, 332.
- (175) Wight, C. A.; Andrews, L. *J. Mol. Spectrosc.* 1978, 72, 342.
- (176) Tevault, D. E.; Smardzewski, R. R. *J. Chem. Phys.* 1978, 69, 3182.
- (177) Lee, Y. P.; Pimentel, G. C. *J. Chem. Phys.* 1978, 69, 3063.
- (178) Tevault, D. E.; Smardzewski, R. R. *J. Am. Chem. Soc.* 1978, 100, 3955.
- (179) Bondybey, V. E.; Brus, L. E. *J. Chem. Phys.* 1975, 62, 620; 1976, 64, 3724.
- (180) Brus, L. E.; Bondybey, V. E. *J. Chem. Phys.* 1976, 65, 71.
- (181) McIntosh, D.; Ozin, G. A. *Inorg. Chem.* 1976, 15, 2869; 1977, 16, 59.

- (182) Bondybey, V. E.; Bearder, S. S.; Fletcher, C. *J. Chem. Phys.* 1975, 64, 5243. Beeken, P.; Mandich, M.; Flynn, G. *Ibid.* 1982, 76, 5995.
- (183) Gole, J. L.; English, J. H.; Bondybey, V. E. *J. Phys. Chem.* 1982, 86, 2560. Bondybey, V. E.; English, J. H. *Ibid.* 1983, 87, 4647.
- (184) Ozin, G. A.; Mitchell, S. A.; McIntosh, D. F.; Matta, S. M.; Garcia-Prieto, J. *J. Phys. Chem.* 1983, 87, 4651.
- (185) Mitchell, S. A.; Kenney-Wallace, G. A.; Ozin, G. A. *J. Am. Chem. Soc.* 1981, 103, 6030.
- (186) Bondybey, V. E.; Albiston, C. *J. Chem. Phys.* 1978, 68, 3172.
- (187) Sonntag, B., in ref 19, Part II, p 1021.